

Instructions

Tektronix

**THM 550, THM 560 & THM 565
TekMeter™**

070-8840-01

This document applies to firmware version 2.00
and above.

**Please check for change information
at the rear of this manual.**

Second Edition: September 1994



Copyright © Tektronix, Inc. 1993, 1994. All rights reserved. Licensed software products are owned by Tektronix or its suppliers and are protected by United States copyright laws and international treaty provisions.

Use, duplication, or disclosure by the Government is subject to restrictions as set forth in subparagraph (c)(1)(ii) of the Rights in Technical Data and Computer Software clause at DFARS 252.227-7013, or subparagraphs (c)(1) and (2) of the Commercial Computer Software – Restricted Rights clause at FAR 52.227-19, as applicable.

Tektronix products are covered by U.S. and foreign patents, issued and pending. Information in this publication supercedes that in all previously published material. Specifications and price change privileges reserved.

Printed in the U.S.A.

Tektronix, Inc., P.O. Box 1000, Wilsonville, OR 97070-1000

TEKTRONIX and TEK are registered trademarks of Tektronix, Inc.

TekMeter is a registered trademark of Tektronix, Inc.

WARRANTY

Tektronix warrants that this product will be free from defects in materials and workmanship for a period of one (1) year from the date of shipment. If any such product proves defective during this warranty period, Tektronix, at its option, either will repair the defective product without charge for parts and labor, or will provide a replacement in exchange for the defective product.

In order to obtain service under this warranty, Customer must notify Tektronix of the defect before the expiration of the warranty period and make suitable arrangements for the performance of service. Customer shall be responsible for packaging and shipping the defective product to the service center designated by Tektronix, with shipping charges prepaid. Tektronix shall pay for the return of the product to Customer if the shipment is to a location within the country in which the Tektronix service center is located. Customer shall be responsible for paying all shipping charges, duties, taxes, and any other charges for products returned to any other locations.

This warranty shall not apply to any defect, failure or damage caused by improper use or improper or inadequate maintenance and care. Tektronix shall not be obligated to furnish service under this warranty a) to repair damage resulting from attempts by personnel other than Tektronix representatives to install, repair or service the product; b) to repair damage resulting from improper use or connection to incompatible equipment; or c) to service a product that has been modified or integrated with other products when the effect of such modification or integration increases the time or difficulty of servicing the product.

THIS WARRANTY IS GIVEN BY TEKTRONIX WITH RESPECT TO THIS PRODUCT IN LIEU OF ANY OTHER WARRANTIES, EXPRESSED OR IMPLIED. TEKTRONIX AND ITS VENDORS DISCLAIM ANY IMPLIED WARRANTIES OF MERCHANTABILITY OR FITNESS FOR A PARTICULAR PURPOSE. TEKTRONIX' RESPONSIBILITY TO REPAIR OR REPLACE DEFECTIVE PRODUCTS IS THE SOLE AND EXCLUSIVE REMEDY PROVIDED TO THE CUSTOMER FOR BREACH OF THIS WARRANTY. TEKTRONIX AND ITS VENDORS WILL NOT BE LIABLE FOR ANY INDIRECT, SPECIAL, INCIDENTAL, OR CONSEQUENTIAL DAMAGES IRRESPECTIVE OF WHETHER TEKTRONIX OR THE VENDOR HAS ADVANCE NOTICE OF THE POSSIBILITY OF SUCH DAMAGES.

Service Assurance

If you have not already purchased Service Assurance for your TekMeter, this valuable opportunity is still available.

Advantages

- Conveniently arrange lifetime repair and calibration support.
- Priced well below the cost of a single repair or calibration.
- Tektronix metrology expertise worldwide will expand your internal resources.

Repair Protection provides post-warranty repair support whenever needed. You may purchase up to three years of Repair Protection.

Calibration Services provide annual calibration of your TekMeter, standards compliance and required audit documentation, recall assurance, and reminder notification of scheduled calibration. Calibration Services begin at the end of your first year of ownership, and you may purchase up to five years of support.

Purchase Repair Protection or Calibration Services, or both, to meet your needs. You can have confidence that your TekMeter investment is protected.

To order Service Assurance, please contact your Tektronix representative with the information below. Service Assurance may not be available in some locations outside the United States of America.

- Name
- Company
- Address
- City, State, Postal Code
- Country
- Phone
- VISA/MC and expiration date, or purchase order number
- Repair Protection (1, 2, or 3 years)
- Calibration Service (1, 2, 3, 4, or 5 years)
- Date of Purchase
- Instrument Serial Number
- TekMeter Model—THM 550, THM 560 or THM 565

Table of Contents

General Safety Summary	1
Overview	4
Getting Started	5
Installing Batteries	5
Adjust Offset	6
DMM Operations	7
AC / DC Volts Measurement	8
Current Measurement	9
Max/Min Values	10
Ohms and Continuity	11
Diode Test	11
Hold Values	12
DMM Menus	13
DMM Menu Tree	14
DMM Main Menus	15
Probes	16
Filter	16
DMM Sto/Rec Menu	17
Scope Operations	19
Using Channel 1	20
Using Channel 2 (THM 560 and THM 565)	20
Positioning Waveforms	21
Scaling (Sizing) Waveforms	22
Using Cursors	23
Triggering	24
Waveform ON/OFF	25
RUN/HOLD	25
Scope Menus	26

Scope Menu Tree	27
Scope Main Menus	28
Operation Mode	29
Measure Modes	30
Input Modes	31
Acquire Modes	33
Trigger Menus	35
Scope Sto/Rec Menu	37
Utility Menus	38
Scope Applications	40
Detecting Line Disturbances	40
Displaying PWM Motor Drive Waveforms (THM 565)	42
Three Phase Voltage (THM 560 and THM 565)	
Delta (Δ) Configuration	43
Three Phase Voltage (THM 560 and THM 565)	
Wye (Y) Configuration	45
Transformer Harmonic Derating Factor (THDF)	47
Measuring True Power (THM 560, THM 565)	48
Appendix A: Specifications	49
Appendix B: Optional Accessories	57
Appendix C: Troubleshooting	59
Instrument Problems	59
Reducing Noise Pickup	60
Appendix D: Replaceable Parts	61

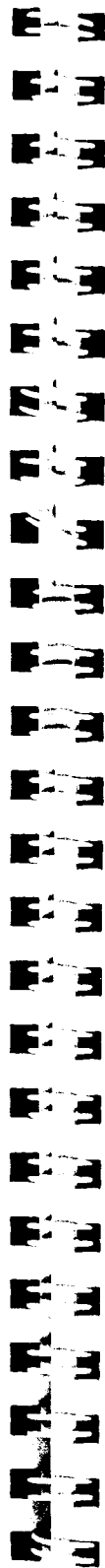

General Safety Summary

Review the following safety precautions to avoid injury and prevent damage to this product or any products connected to it.

Only qualified personnel should perform service procedures.

Injury Precautions

Avoid Electric Overload

To avoid electric shock or fire hazard, do not apply a voltage to a terminal that is outside the range specified for that terminal.

Do Not Operate Without Covers

To avoid electric shock or fire hazard, do not operate this product with covers or panels removed.

Do Not Float Outside Limits

Do not apply a potential to any input, including the common input, that varies from ground by more than the maximum rating for the product.

Do Not Operate in Explosive Atmosphere

To avoid injury or fire hazard, do not operate this product in an explosive atmosphere.

Product Damage Precautions

Use Proper Power Source

Do not operate this product from a power source that applies more than the voltage specified.

Do Not Operate With Suspected Failures

If you suspect there is damage to this product, have it inspected by qualified service personnel.

Do Not Leave Exposed to Sunlight

Do not store or leave this product where the LCD display will be exposed to direct sunlight for long periods of time.

Safety Terms and Symbols

Terms in This Manual

These terms may appear in this manual:



WARNING. Warning statements identify conditions or practices that could result in injury or loss of life.



CAUTION. Caution statements identify conditions or practices that could result in damage to this product or other property.

Terms on the Product

These terms may appear on the product:

DANGER indicates an injury hazard immediately accessible as you read the marking.

WARNING indicates an injury hazard not immediately accessible as you read the marking.

CAUTION indicates a hazard to property including the product.



Symbols on the Product

The following symbols may appear on the product:



DANGER
High Voltage



Protective Ground
(Earth) Terminal



ATTENTION
Refer to
Manual



Double
Insulated

Certifications and Compliances

Compliances

Consult the product specifications for IEC Installation Category, Pollution Degree, and Safety Class.

Overview

The THM 550, THM 560, and THM 565 TekMeters provide you with the features of a complete digital multimeter (DMM), and in addition, give you the power of a scope, all in a small portable package that is intuitive and simple to use.

The DMM provides true RMS AC and DC voltage readouts, resistance readouts, continuity testing with an audible signal, and a diode test mode. AC and DC current can be measured using an optional current probe. Additional DMM functions and readouts include a hold feature to freeze the display, min and max readouts to show how a signal has varied, and the instantaneous variation from the last held value (Δ Hold).

The oscilloscope has the world's first Autoranging mode that automates operation completely, so that it always displays a usable signal without operator intervention. When desired, automatic operation can be overridden by using any control. In manual mode, the oscilloscope provides general oscilloscope coupling, triggering, and acquisition modes. Special preconfigured modes instantly set up the oscilloscope for motor testing, transformer THDF measurements, power line monitoring, and power measurements.

Waveforms, settings, and displays can be saved for future reference and use. Test setups can be saved to automate and recall test procedures in the field. Waveforms and screens can be saved in the field to compare them with field samples, and, with the optional Communications Adapter, transferred to a PC for customer reports or to monitor trends.

Whether your application is in field service or on the bench, the THM 500 series instruments are light, simple, portable, and versatile enough to meet your needs.

Getting Started

Installing Batteries

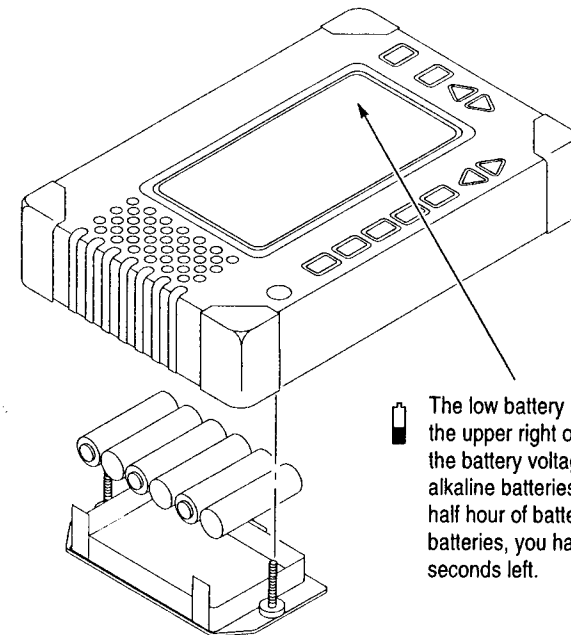

 The low battery indicator appears in the upper right of the display when the battery voltage gets low. With alkaline batteries, you have about a half hour of battery life. With NiCd batteries, you have only about 30 seconds left.

(6) size AA batteries.

Maximum life alkaline or long-life NiCd batteries are recommended.

Adjust Offset

Before performing any measurements using the Scope mode, adjust the offset setting. This is especially important if the THM 500 series instruments has been left without a power source for several hours.

NOTE. Pressing the ON/OFF button without batteries installed instantly uncalibrates the offset settings.

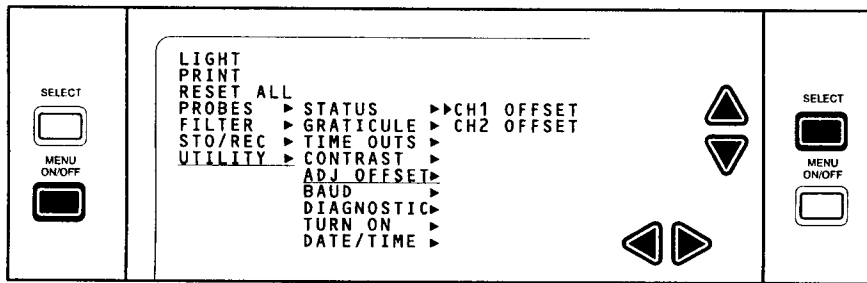

Display menu.

Use direction buttons to point to the channel offset selection. Adjust the offset for each channel.

Select.

The offset is set at the factory at room temperature. If operating the THM 500 series instruments at extreme temperatures, perform the offset adjustment to ensure proper scope measurements.

DMM Operations

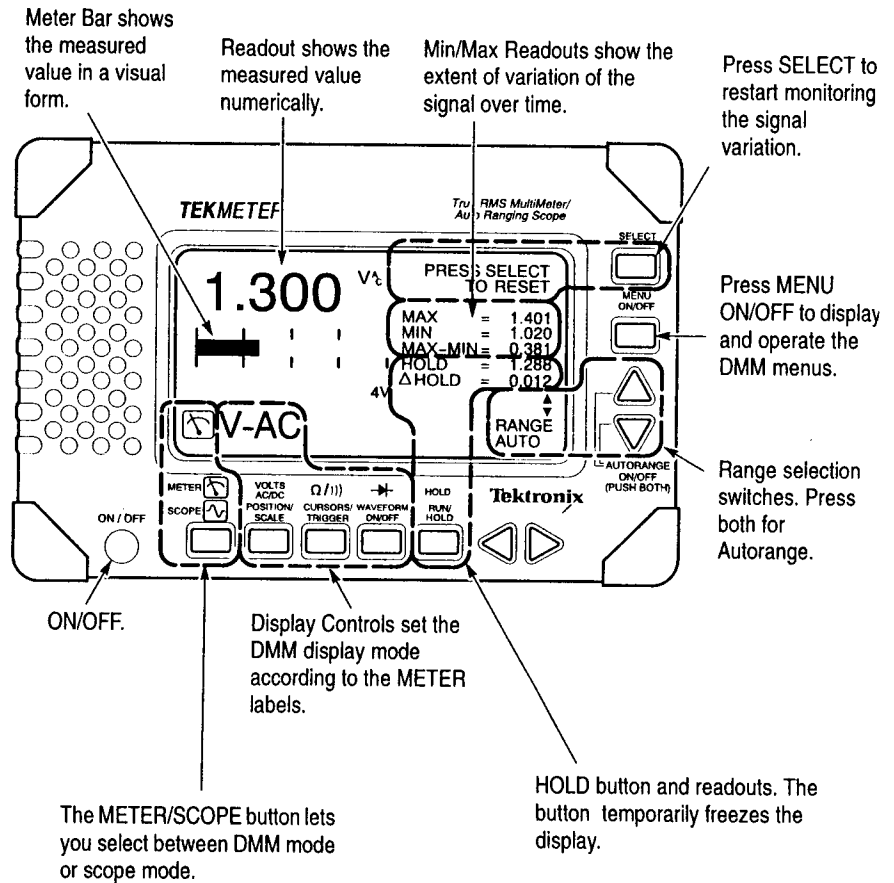

Note: To ensure maximum accuracy in DMM measurements, set the DMM filter for the line frequency used in your location, either 50 Hz or 60 Hz. See DMM Filter on page 16.

AC / DC Volts Measurement

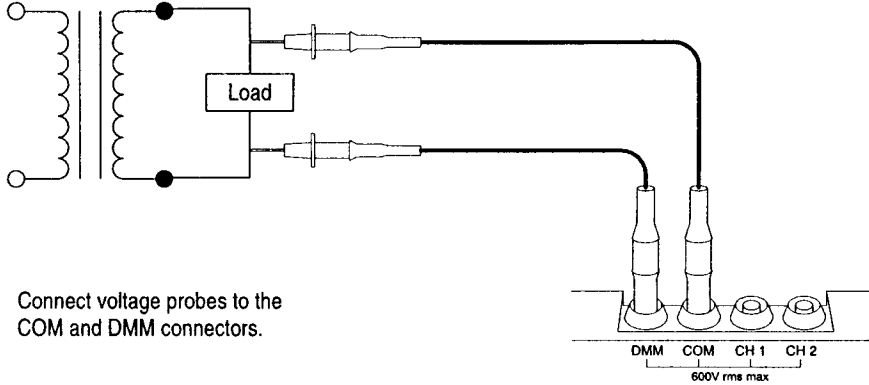

Connect voltage probes to the COM and DMM connectors.

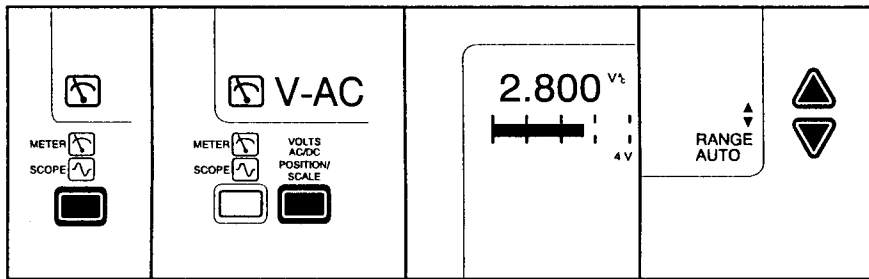

Press if in scope mode.

Press to toggle between AC or DC measurements.

Read results.

Adjust range only if needed. Press both to set to Autorange mode.

Current Measurement

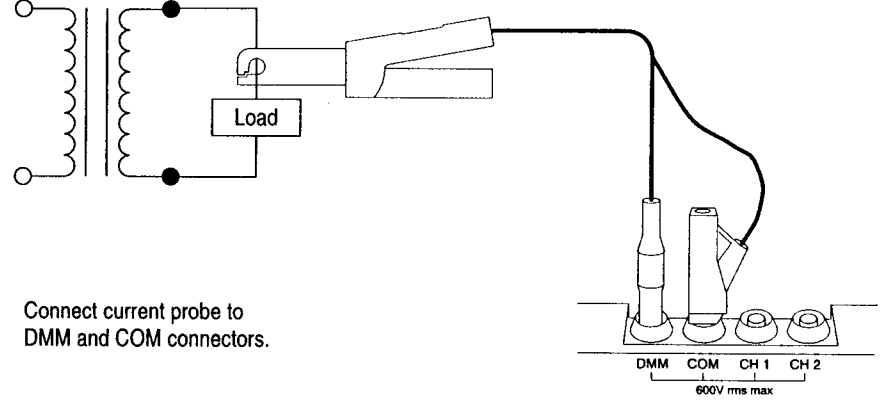

Connect current probe to DMM and COM connectors.

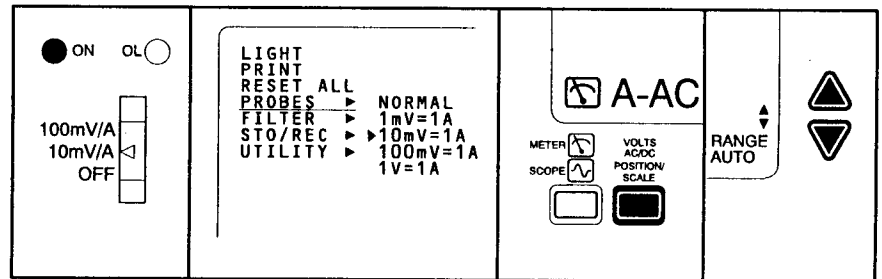

Set switch on current probe.

Use the menu to specify that you have a current probe and match the scale factor of the current probe.

The readouts change to show Amperes.

Adjust range only if needed. Press both to set to Autorange mode.

Max/Min Values

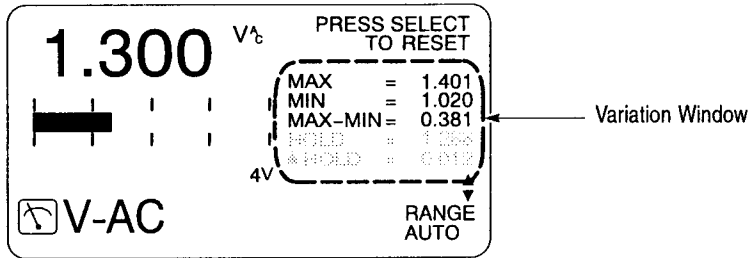

The measurement window always displays the instantaneous value. The variation window displays the maximum and minimum values and the difference between the max and min measurements.

The MAX value displays the maximum value measured. This value only changes with a higher measurement value.

The MIN value displays the minimum value measured. This value only changes with a lower measurement value.

The MAX-MIN value is the measurement result of subtracting the MIN value from the MAX value.

NOTE. Exceeding the measurement capability of a manual range setting stops the MIN, MAX, and MAX - MIN measurements. Changing the range restarts these measurements.

Pressing the SELECT button resets the MAX, MIN, and MAX-MIN values.

The Hold and ΔHold values are explained on page 12.

Ohms and Continuity

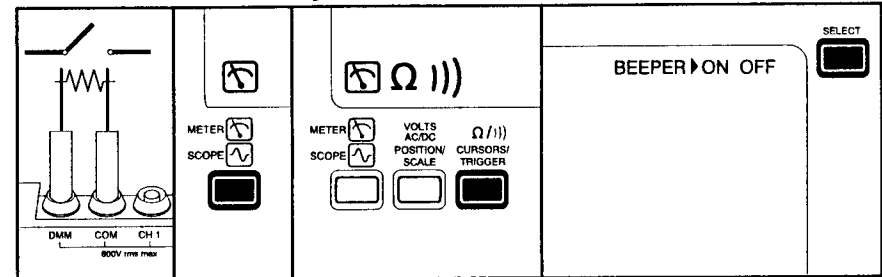

Connect probes across resistor or circuit.

Press if in scope mode.

Press once or twice to show desired display.

Press Select to turn continuity beeper on or off.

Diode Test

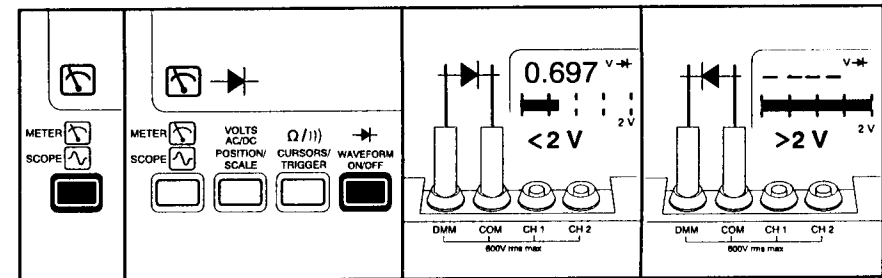

Press if in scope mode.

Press to display diode test readout.

Check forward voltage drop < 2 V.

Check reverse voltage drop > 2V (infinity readout).

Hold Values

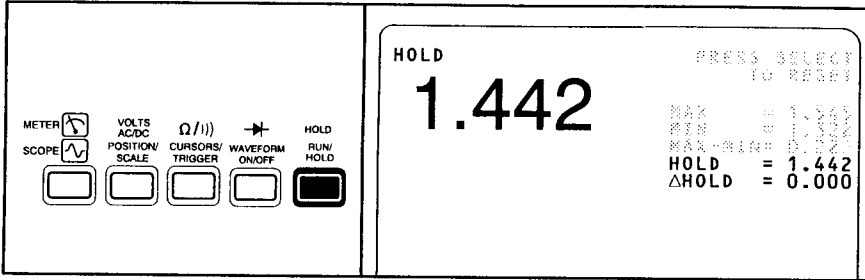

Press the Hold button to freeze the display.

Hold shows reading at last hold.

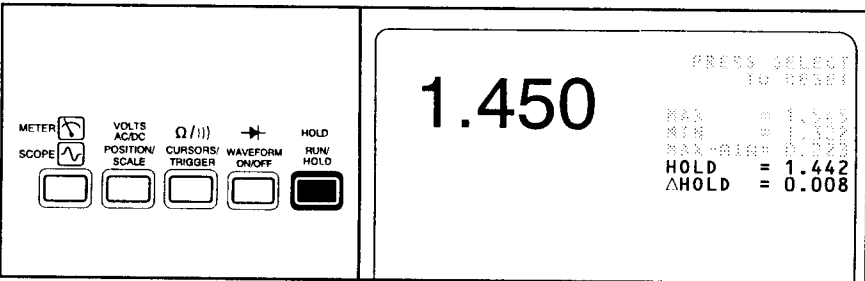

Press the Hold button again to restart the display.

ΔHold shows the difference from last held value and the present measured value.

DMM Menus

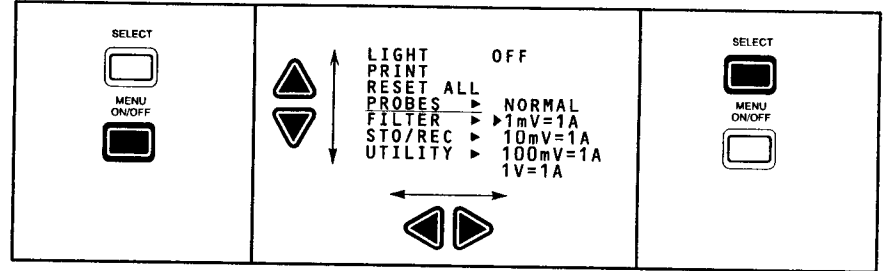

Display menus.

Use direction buttons to navigate through the menus.

Press SELECT if the message "PRESS SELECT TO CHOOSE" is displayed.

If "PRESS SELECT TO CHOOSE" appears, the SELECT button must be pushed to make the selection. If the message does not appear, THM 500 series instruments automatically changes to the chosen selection.

DMM Menu Tree

The following menu tree provides a quick look at the available DMM menus, helping you to locate specific menu choices. Each DMM menu is described in the following pages.

LIGHT		UTILITY	CONTRAST	ADJUST
PRINT			GRATICULE	NONE CROSSHAIR GRID
RESET ALL			TIME OUTS	POWER OFF BACKLIGHT
PROBES	NORMAL 1mV=1A 10mV=1A 100mV=1A 1V=1A		STATUS	VIEW PRINT
FILTER	50 Hz 60 Hz		ADJ OFFSET	CH1 OFFSET CH2 OFFSET
STO/REC	STO SCREEN REC SCREEN PRINT SCRN STO SETUP REC SETUP		BAUD	1200 9600
			DIAGNOSTIC	INTERNAL DISPLAY CYCLE
			TURN ON	NO RESET RESET
			DATE/TIME	SET DATE SET TIME

DMM Main Menus

LIGHT
PRINT
RESET ALL
PROBES
FILTER
STO/REC
UTILITY

- LIGHT turns on the display backlight (THM 565 only).
- PRINT sends the current DMM display to a connected printer. The printer must use Epson-style commands and be connected through the optional THMCOM1 Communications Adapter. If a printer is not connected, press MENU ON/OFF to cancel.
- RESET ALL restores all settings to factory default. Display contrast and all saved settings, waveforms, and screens are preserved.
- PROBES lets you select between using voltage probes (normal) and current probes. See page 16.
- FILTER lets you choose the proper filter for your environment to increase your measurement accuracy. See page 16.
- STO/REC saves display screens and instrument settings to memory or recalls them. See page 17.
- UTILITY lets you change certain instrument characteristics. These settings are generally set only once. The Utility menus are identical when accessed through either the DMM or scope menus. See page 38 for descriptions of these menus.

Probes

LIGHT	
PRINT	
RESET ALL	
PROBES	NORMAL
FILTER	1mV=1A
STO/REC	10mV=1A
UTILITY	100mV=1A
	1V=1A

The Probes menu lets you specify whether a voltage (normal) or current probe is used. If using a current probe, specify the scale factor.

Filter

LIGHT	
PRINT	
RESET ALL	
PROBES	
FILTER	50Hz
STO/REC	60Hz
UTILITY	

The Filter menu lets you select what AC line noise to reject during DC measurements.

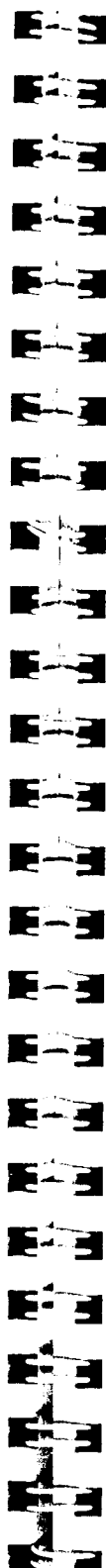

DMM Sto/Rec Menu

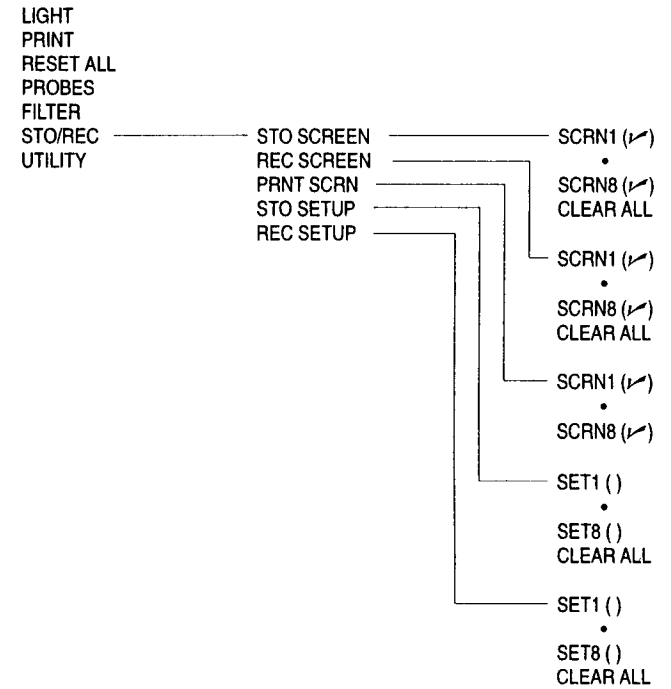

The DMM Store/Recall menu allows you to store and recall entire screen displays and instrument setups. Saved screens can be sent to a printer directly. The number of memory locations available for each type of information to store is dependent on the THM 500 series instruments model. See memories on page 53. A check appears next to each location containing saved data.

Scope Operations

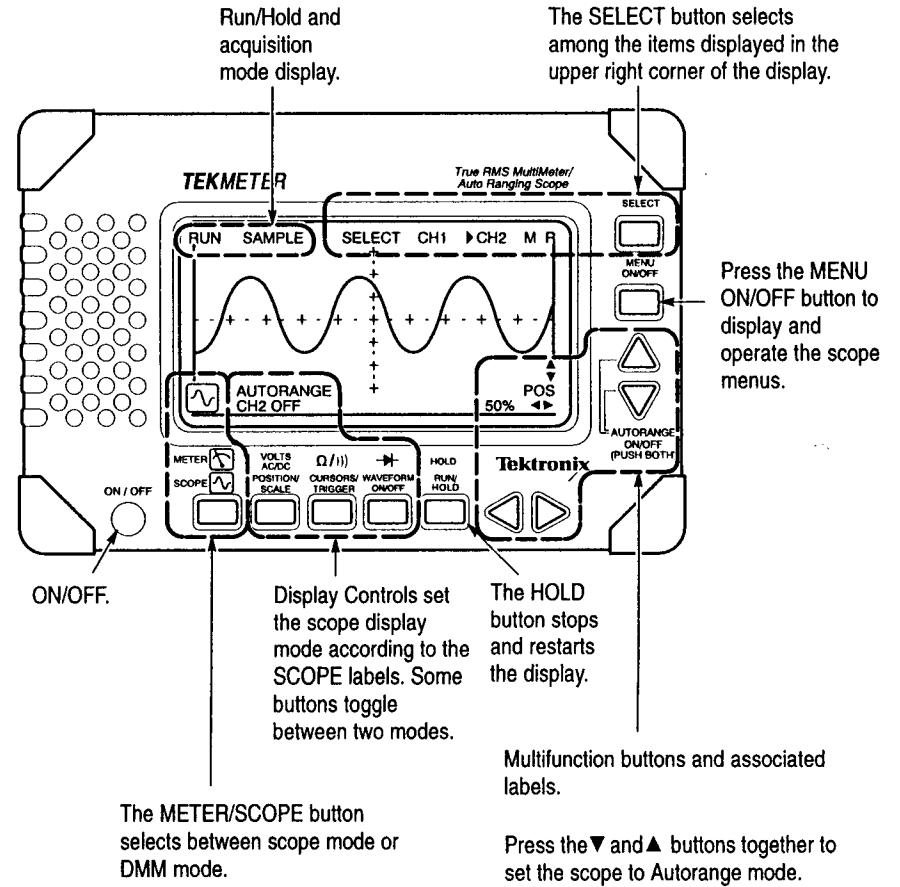

Using Channel 1

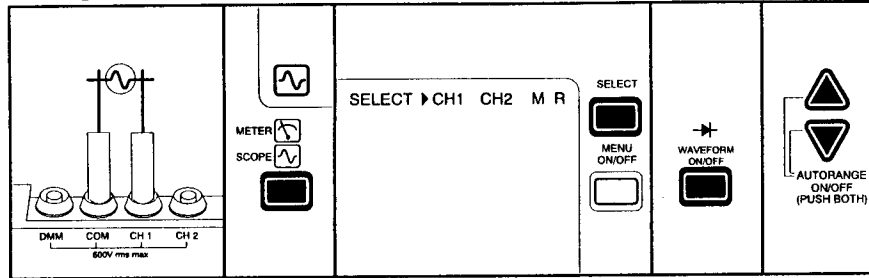

Connect COM and CH1 probes across signal source.

Press if in DMM mode.

Select CH1. (If the Select label is not displayed, press the POSITION/SCALE button.)

Press if not already on.

Press both buttons together to autorange.

Using Channel 2 (THM 560 and THM 565)

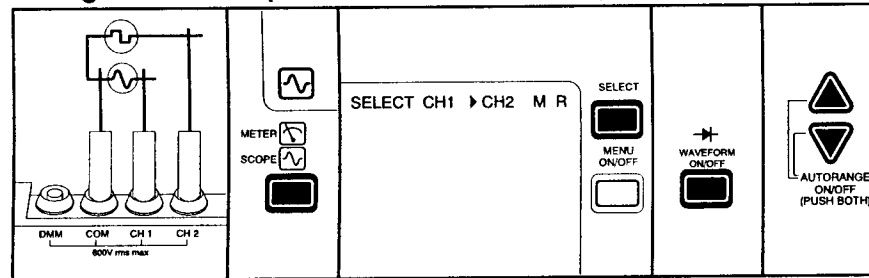

Connect COM and CH2 probes across signal source.

Press if in DMM mode.

Select CH2. (If the Select label is not displayed, press the POSITION/SCALE button.)

Press if not already on.

Press both buttons together to autorange.

Positioning Waveforms

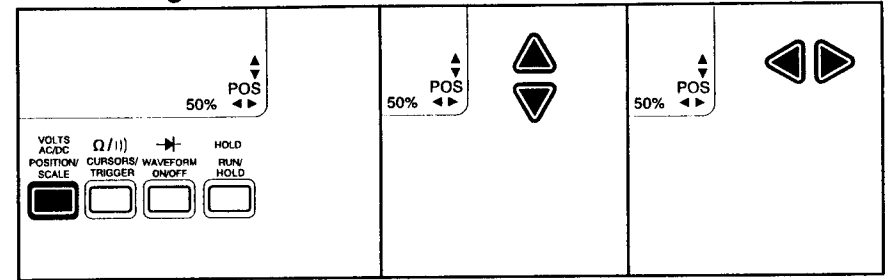

Press to display position label.

Adjust vertical position of display.

Adjust horizontal position of display (horizontal position of trigger event). See the example below.

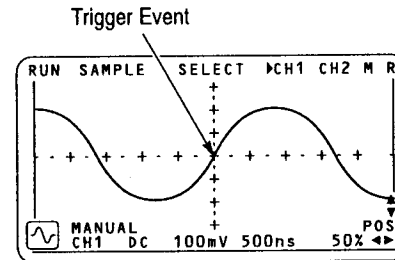

A horizontal position of 50% means the trigger event is at center screen.

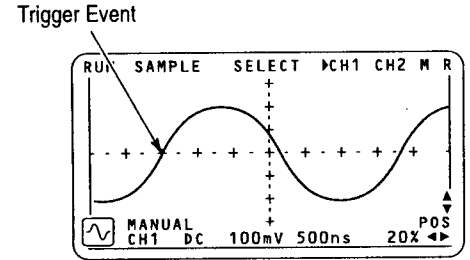

A horizontal position of 20% means the trigger event is two divisions from the left edge of the screen.

NOTE. A trigger event occurs when the waveform crosses the trigger threshold level. When this occurs, the waveform is displayed. See Triggering on page 24.

NOTE. The Autorange mode is exited anytime a change to the scale factors, position, or triggering is made by the user.

Scaling (Sizing) Waveforms

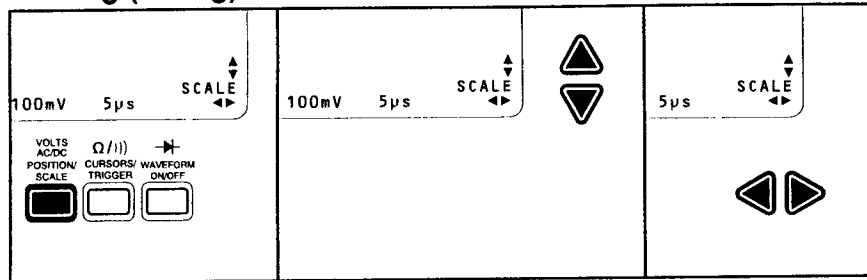

Press to display Scale label.

Press to change volts/division scale factor.

Press to change seconds/division scale factor.

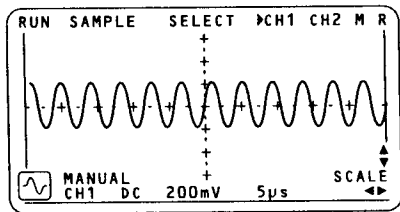

Horizontal scale set to 5µ per division.
Vertical scale is set to 200mV per division.

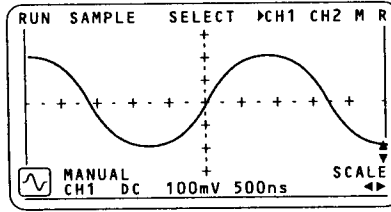

Horizontal scale set to 500ns per division.
Vertical scale is set to 100mV per division.

NOTE. The Autorange mode is exited anytime a change to the scale factors, position, or triggering is made by the user.

Using Cursors

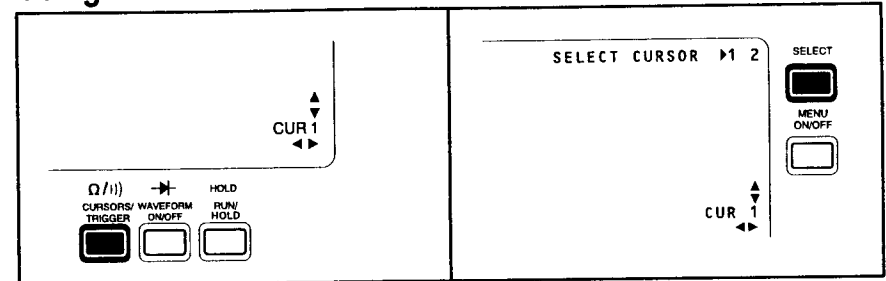

Press to display Cursor label and cursor bars.

Press Select to toggle between cursor 1 (CUR 1) and cursor 2 (CUR 2).

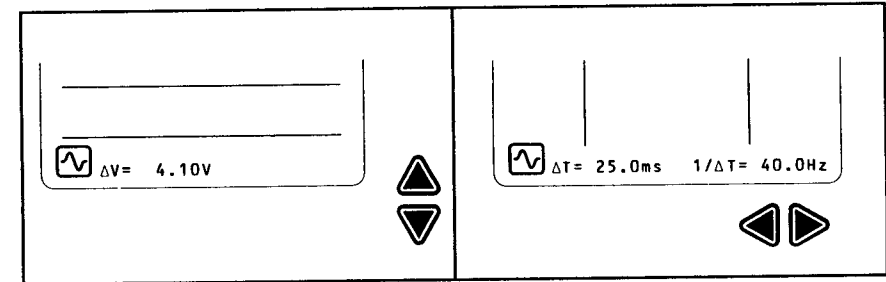

Display and position the voltage cursors.

Display and position the time cursors.

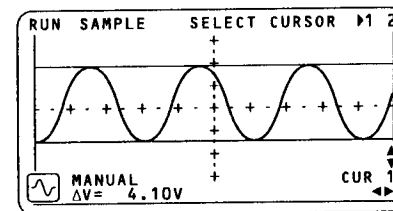

Voltage cursors displayed. ΔV measures the voltage between the cursors.

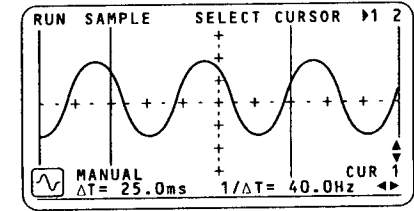

Time cursors displayed. ΔT is the time measured between cursors. 1/ΔT is the frequency measurement.

Triggering

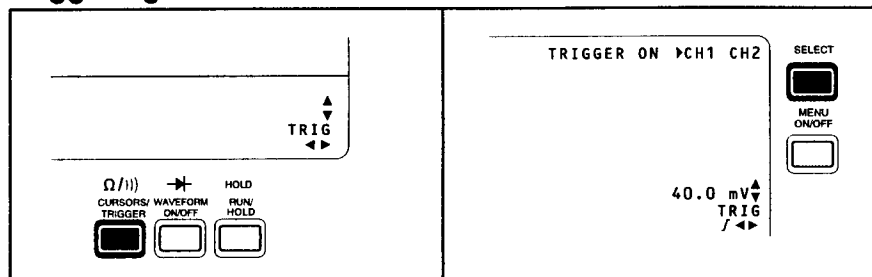

Press to display Trigger label and trigger bar. Select the channel to use as the trigger source.

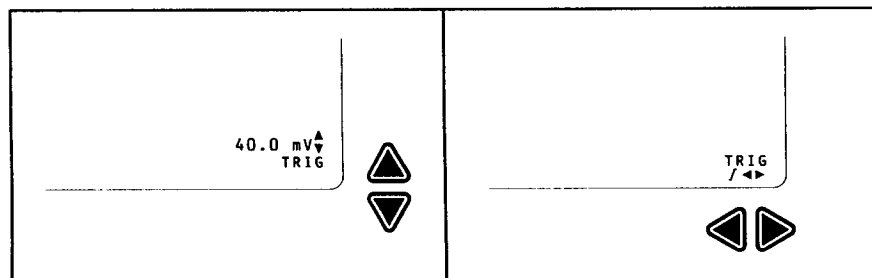

Adjust the trigger level. Select the trigger slope (rising or falling).

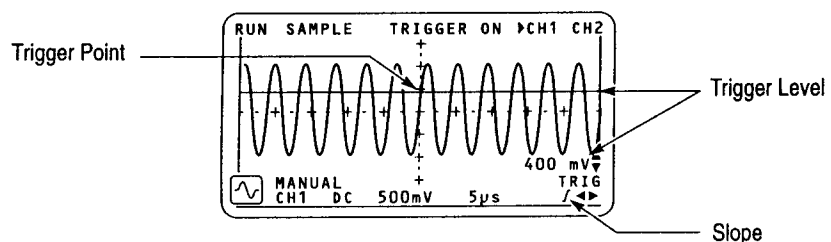

This example shows the trigger source set to channel 1 and the trigger event occurring when the rising edge of the signal exceeds 400 mV. The actual trigger point is the intersection of the trigger level (400 mV) and the horizontal position (50%).

NOTE. The Autorange mode is exited anytime a change to the scale factors, position, or triggering is made by the user.

Waveform ON/OFF

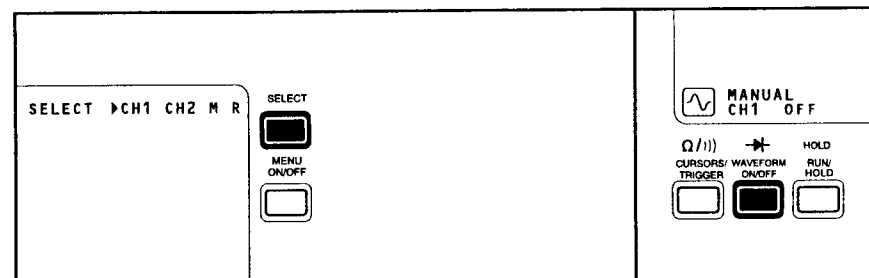

Press to select which display the WAVEFORM ON/OFF button affects. Press to turn waveform displays on or off.

CH1 is the channel 1 scope input.
 CH2 is the channel 2 scope input.
 M is the math waveform display last chosen (CH1-CH2 or CH1+CH2).
 R is the last waveform stored in memory. See page 37.

RUN/HOLD

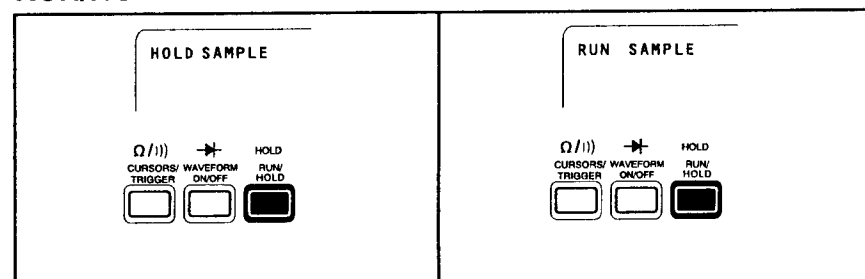

Press to freeze (hold) the display, stopping the acquisition of the waveform. Press to start (run) the display, starting the acquisition of the waveform.

Using Run and Hold does not affect the operation of the Autorange feature. Use the RUN/HOLD button to arm the scope while waiting for a trigger event when using single-shot trigger (see page 35).

Scope Menus

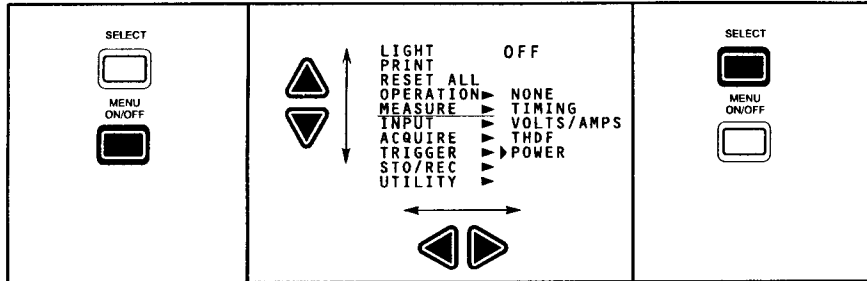

Display menus.

Use direction buttons to navigate through the menus.

Press Select if the message "PRESS SELECT TO CHOOSE" is displayed.

If "PRESS SELECT TO CHOOSE" appears, the SELECT button must be pushed to make the selection. If the message does not appear, THM 500 series instruments automatically changes to the chosen selection.

Scope Menu Tree

The menu tree below provides a quick look at the available scope menus, helping locate specific menu choices. Each scope menu is described in the following pages.

LIGHT		TRIGGER	MODE	AUTO NORMAL SINGLE
PRINT			SLOPE	NEGATIVE POSITIVE
RESET ALL			MOTOR	OFF ON
OPERATION	MANUAL AUTORANGE LINE TEST MOTOR TEST		STO/REC	STO SCREEN REC SCREEN PRINT SCRIN STO SETUP REC SETUP STO WAVE REC WAVE
MEASURE	NONE TIMING VOLTS/DIV THDF POWER		UTILITY	CONTRAST GRATICULE ADJUST NONE CROSSHAIR GRID TIME OUTS POWER OFF BACKLIGHT STATUS VIEW PRINT ADJ OFFSET CH1 OFFSET CH2 OFFSET BAUD 1200 9600 DIAGNOSTIC INTERNAL DISPLAY CYCLE
INPUT	CH1 CPLG DC AC GND CH1 INVERT OFF ON CH1 PROBE NORMAL 1mV=1A 10mV=1A 100mV=1A 1V=1A CH2 CPLG NEGATIVE POSITIVE CH2 INVERT OFF ON MATH OFF CH1 - CH2 CH1 + CH2			
ACQUIRE	SAMPLE SPIKE DETECT SMOOTH DYNAMIC DSP		TURN ON	NO RESET RESET
			DATE/TIME	SET DATE SET TIME

Scope Main Menus

LIGHT
PRINT
RESET ALL
OPERATION
MEASURE
INPUT
ACQUIRE
TRIGGER
STO/REC
UTILITY

- LIGHT turns on the display backlight (THM 565 only).
- PRINT sends the current scope display to a connected printer. The printer must use Epson-style commands and be connected through the optional THMCOM1 Communications Adapter. If a printer is not connected, press MENU ON/OFF to cancel.
- RESET ALL restores all settings to factory default. Display contrast and all saved settings, waveforms, and screens are preserved.
- OPERATION lets you choose the operation of the THM 500 series instruments. See page 29.
- MEASURE lets you choose preconfigured test setups. See page 30.
- INPUT lets you select signal coupling and signal invert. Current probe factors are set here. See page 31.
- ACQUIRE lets you select how signals are digitally acquired. See page 33.
- TRIGGER lets you select the characteristics the trigger signal must meet to cause a signal to display. See page 35.
- STO/REC saves display screens, waveforms, and instrument settings to memory or recalls them. See page 37.
- UTILITY lets you change certain instrument characteristics. These type of settings are generally set only once. See page 38.

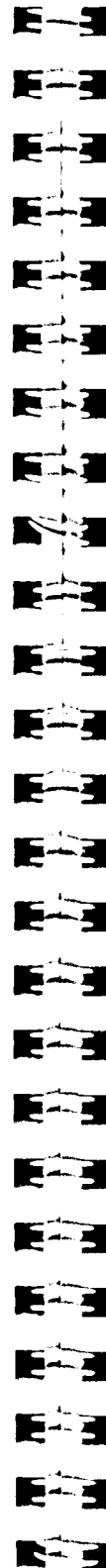

Operation Mode

LIGHT
PRINT
RESET ALL
OPERATION ——— MANUAL
MEASURE AUTORANGE
INPUT LINE TEST
ACQUIRE MOTOR TEST
TRIGGER
STO/REC
UTILITY

Operation Mode selects between instrument operation.

- MANUAL lets you set parameters directly; this prevents all other parameters from automatically changing. Manual can be set without using the menu by directly setting any parameter.
- AUTORANGE sets all parameters for displayed channels based on the input waveform. Autorange can be set without using the menu by pressing the ▲ and ▼ buttons together.

NOTE. The Autorange mode is exited anytime a change to the scale factors, position, or triggering is made by the user.

- LINE TEST captures transient events, such as voltage spikes and sags, on a power line. A dialog screen is displayed requesting line quality parameters. See page 40.
- MOTOR TEST automatically sets the THM 500 series instruments settings to 200V/div, Motor Trigger to On, and the acquisition mode to Spike Detect. This is ideal for measuring 480V inverter output signals of a Pulse Width Modulated (PWM) motor drive. See page 42.

Measure Modes

LIGHT	
PRINT	
RESET ALL	
OPERATION	
MEASURE	NONE
INPUT	TIMING
ACQUIRE	VOLTS/AMPS
TRIGGER	THDF
STO/REC	POWER
UTILITY	

Measure selects from several automated measurement displays.

- NONE turns measurements off.
- TIMING measures the period, frequency, and duty cycle (% of time the voltage is high) of the selected channel.
- VOLTS/AMPS measures the maximum, minimum, and peak-to-peak voltage. Current is measured if using a current probe.
- THDF measures RMS, peak-to-peak, and the THDF of the waveform. See page 47.
- POWER (THM 560 and THM 565 only) measures the RMS current on channel 1 and the RMS voltage on channel 2. True power and the Power Factor (PF) are calculated and displayed. See page 48.



Input Modes

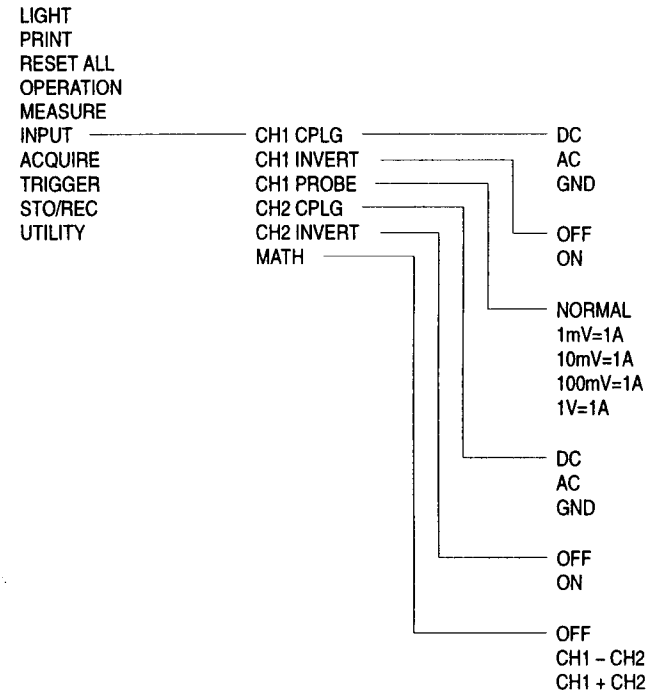

Input mode selections let you choose various actions to apply to the input signal.

- CH1 CPLG (and CH2 CPLG) specifies how the input channel is electrically coupled to the input of the THM 500 series instruments.
 - DC coupling is direct connection.
 - AC coupling removes the DC component of a signal.
 - GND coupling shows the common (not ground) potential.
- CH1 INVERT (and CH2 INVERT) lets you display the signal “upside down.”

- CH1 PROBE lets you specify whether a voltage or current probe is used on channel 1. If using a current probe, the scale factor must be set to match the attached current probe.

NORMAL — Voltage input

1 mV = 1 A — Current input with a conversion factor of 1mV/A.

10 mV = 1 A — Current input with a conversion factor of 10mV/A.

100 mV = 1 A — Current input with a conversion factor of 100mV/A.

1 V = 1 A — Current input with a conversion factor of 1V/A.

- MATH (THM 560 and THM 565 only) determines the characteristics of the math waveform. The math waveform is displayed by selecting M in the channel selection.

OFF turns off the math waveform and is the same as using Waveform On/Off.

CH1-CH2 specifies the operation shown by the math waveform.

CH1+CH2 specifies the operation shown by the math waveform.

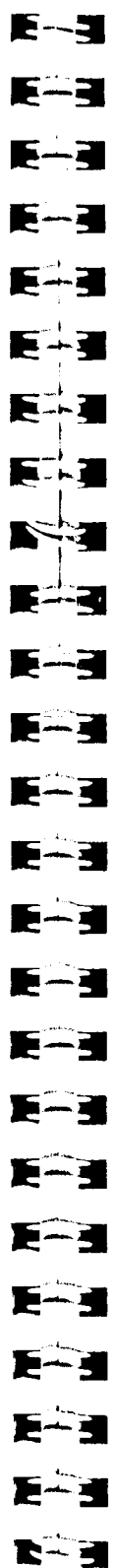

Acquire Modes

LIGHT	
PRINT	
RESET ALL	
OPERATION	
MEASURE	
INPUT	
ACQUIRE	————— SAMPLE
TRIGGER	————— SPIKE DETECT
STO/REC	————— SMOOTH
UTILITY	————— DYNAMIC DSP

ACQUIRE specifies how sampling is performed and how the waveform is displayed.

- SAMPLE (the default) takes one sample for each displayed waveform dot.
- SPIKE DETECT takes many samples and displays the most extreme sample; use this mode to capture glitches and spikes.

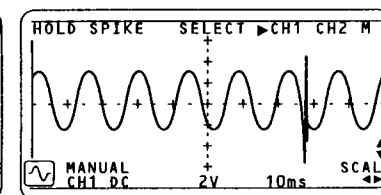
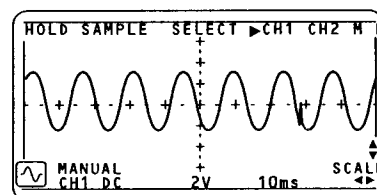

- SMOOTH takes many samples and displays a composite waveform, reducing apparent noise.

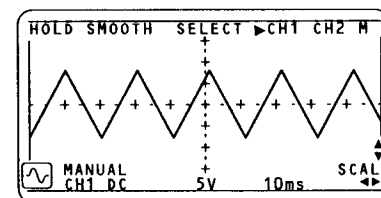
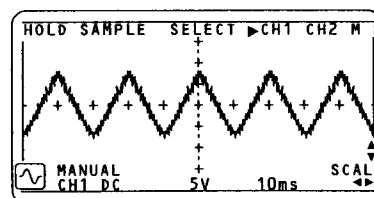

Smooth acts as a low pass filter with the following characteristics.

Time/Div	Frequency
200 nS	2.87 MHz
500 nS	1.18 MHz
1 μ S	531 kHz
2 μ S	256 kHz
5 μ S	126 kHz
10 μ S	62.5 kHz
20 μ S – 60 S	31.5 kHz

- DYNAMIC DSP (Dynamic Display)** acquires multiple waveforms per screen update. It is ideal for capturing fast changing and infrequent events. This results in a “gray scaling” effect similar to analog oscilloscopes.

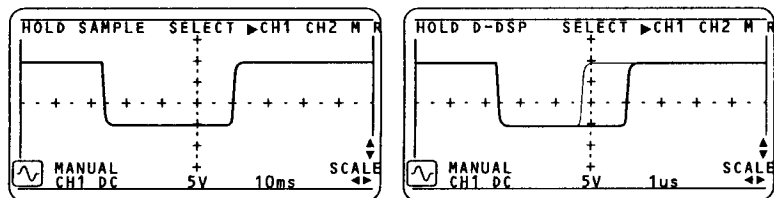

Trigger Menu

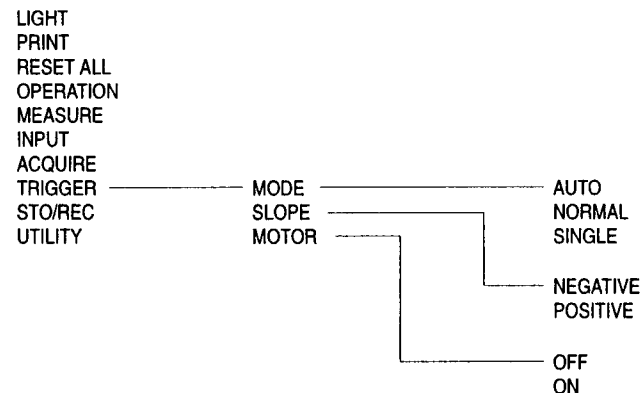

Trigger specifies the parameters needed to trigger the waveform display (cause a sweep).

- MODE** sets the operation of the oscilloscope trigger.
 - AUTO** automatically updates the waveform even if a trigger event is not detected.
 - NORMAL** triggers a waveform sweep (display) when the waveform crosses the trigger level threshold. The waveform will not update again until the waveform crosses the trigger threshold again.
 - SINGLE** triggers a waveform sweep (display) when the waveform crosses the trigger level threshold and then stops. Press the Run/Hold button to rearm for another trigger.
- SLOPE** determines whether the scope triggers on the positive or negative going edge of the waveform as it crosses the trigger threshold level.

Alternately, press the TRIGGER button (twice if not in cursors display) then set with ◀ and ▶ buttons.
- MOTOR** sets the trigger for motor signal detection and is designed to trigger on pulse width modulated waveforms. See page 36 for further details.

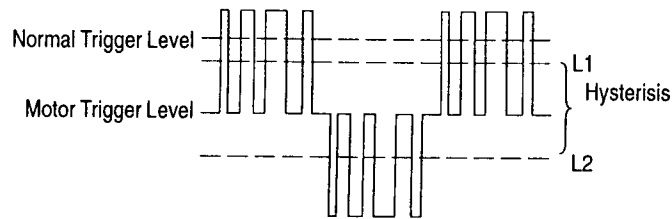

In Normal trigger mode with positive edge selected, the scope triggers on the rising edge of the waveform. However; pulse width modulated waveforms are a series of alternating positive and negative going pulses. With normal triggering, the scope cannot determine which positive pulse to trigger on, resulting in an unstable display.

In the illustration above, motor trigger adds hysteresis to the trigger level. Once the waveform crosses L1, the waveform triggers (stabilizes). The scope will not look for another trigger until the waveform crosses L2. Once L2 has been crossed, the next time the waveform crosses L1, the scope triggers again. (Crossing L2 re-arms the trigger.) Therefore, the scope will always trigger on the first positive-going pulse of the waveform allowing it to lock on the waveform and stabilize on it.

As you can see in the illustration below. Motor trigger can be used to stabilize noisy waveforms which would normally have trigger problems.

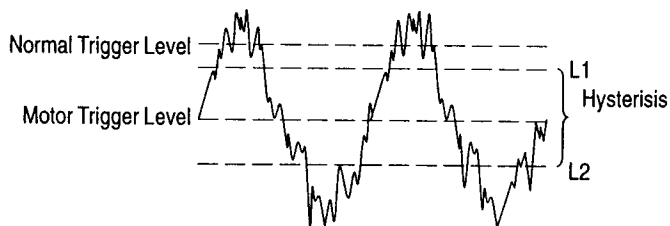

NOTE. MOTOR TEST, in the OPERATION menu, uses motor trigger. If motor trigger is turned off while using MOTOR TEST, the THM 500 series instruments return to manual operation.

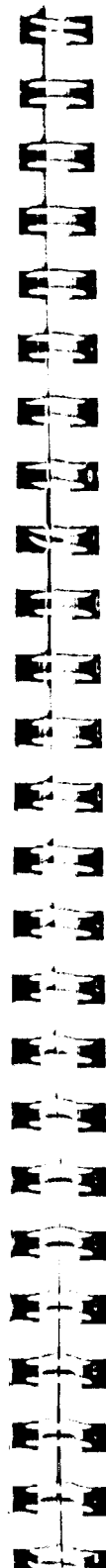

Scope Sto/Rec Menu

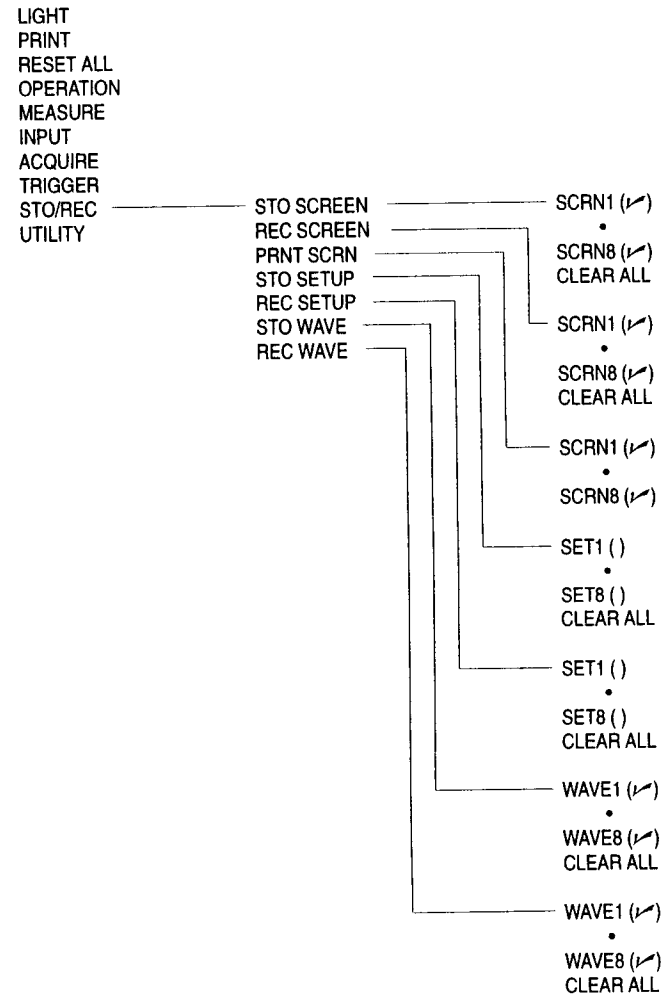

The Store Recall menu allows you to store and recall entire screen displays, instrument setups, and waveforms. You can send saved screens directly to a printer. The number of memory locations available for each type of information to store is dependent on the THM 500 series model. See memories on page 53. A check appears next to each location containing saved data.

Utility Menus

LIGHT
PRINT
RESET ALL
OPERATION
MEASURE
INPUT
ACQUIRE
TRIGGER
STO/REC
UTILITY

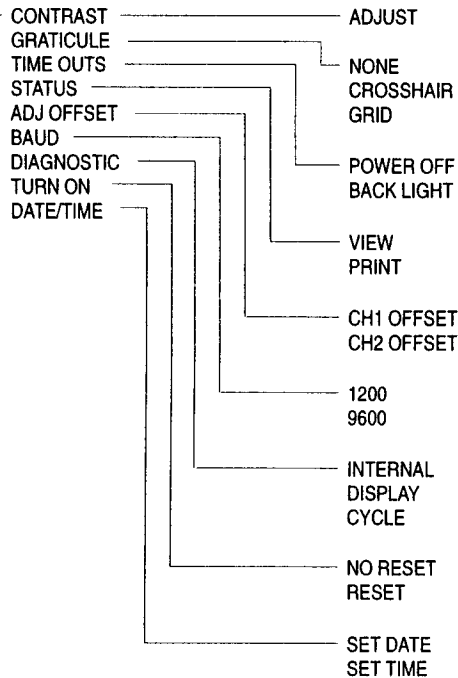

- CONTRAST lets you control display darkness and contrast. The contrast setting is not affected by the Reset All function.
- GRATICULE changes the type of grid (none, crosshair, or grid) on the oscilloscope display. The graticule is not displayed when using the Meter mode.
- TIME OUTS let you set the amount of time before the battery saving functions activate: automatic power off and automatic backlight off.

- STATUS displays the instrument type and firmware. If a printer is not connected when PRINT is selected, press MENU ON/OFF to cancel.
- ADJ OFFSET removes any offset from the specified scope channel. This has no effect on the DMM input. You will be asked to disconnect the probe from the specified channel, and press the Select button to complete the automatic adjustment.
- BAUD sets communication speed (baud rate) of the printer/computer interface. This is for use with the optional THMCOM1 Communications Adapter.
- DIAGNOSTIC performs instrument self tests.

NOTE. Activating the diagnostics resets all parameters and erases all stored waveforms, settings, and screens.

- TURN ON allows you to choose how the instrument powers on.
 - NO RESET lets all previous instrument settings remain when the instrument is powered off and then on.
 - RESET clears all previous instrument settings every time the instrument is powered off and then on (including when automatically powered off). Items stored in memory locations are not affected. If reset is selected, the THM 500 series instruments powers on in the AC volts meter mode. This mode is useful to always return the THM 500 series instrument to a known state after every power off.
- DATE/TIME (THM 565 only) lets you set the date and time for time stamping of stored waveforms and when using LINE TEST.

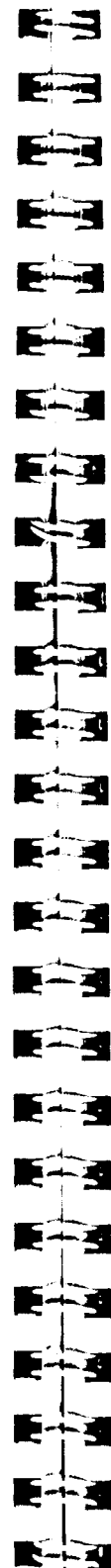

Scope Applications

Detecting Line Disturbances

Connect COM and CH1 across the line voltage.

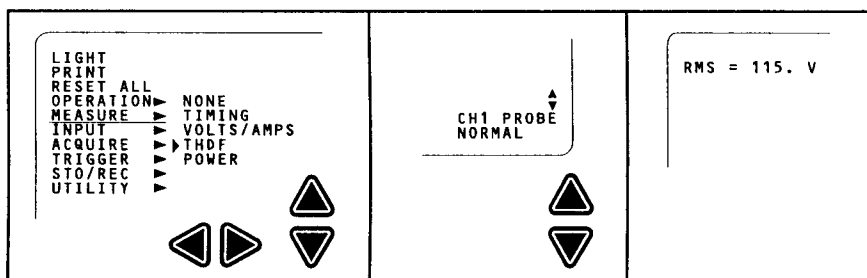
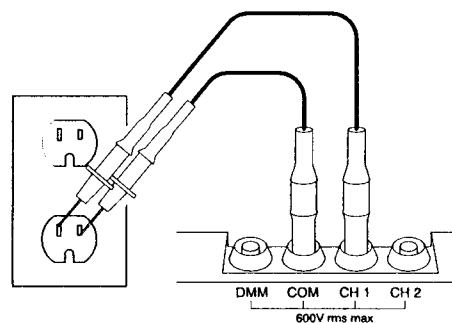

Use menu to select THDF measurement.

Set CH1 PROBE to NORMAL.

Read RMS volts results on display.

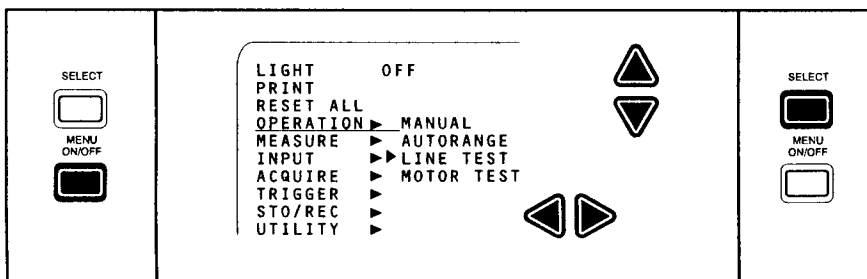

Display menu.

Use direction buttons to show Line Test.

Select.

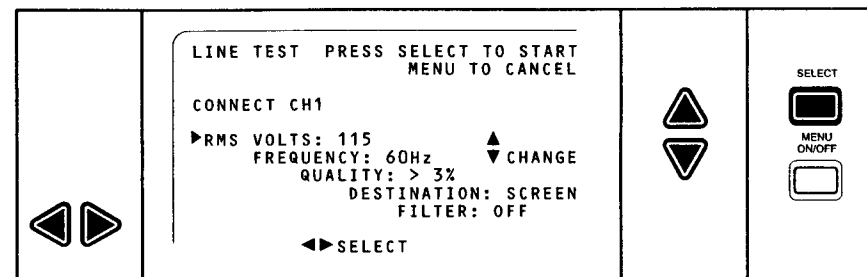

Select the parameter to change.

Specify line test parameters from the dialog screen.

Change the parameter.

- Set the RMS value to the voltage measured using the THDF measurement..
- Set the Frequency to the line frequency (from 45 Hz to 65 Hz in 5Hz steps).
- Set Quality to allow a percent of signal error (from a perfect sine wave) before failing the test. You have these settings to choose from: >3%, >12%, >21%, and >30%.
- Destination determines where a failed signal is written to. Choosing screen writes the failure to the screen and then continues the test. Choosing memory writes the failure to an empty location. Clear the memory locations to store the maximum amount of failures. Choosing Print sends the failure to a connected printer. The THMCOM1 Communications Adapter is required. Failures occurring while the THM 500 series instruments are writing failures are not captured.
- Filter lets you turn the 32 kHz filter on or off.

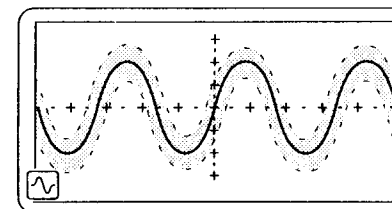

A quality window is created around the displayed waveform. This is an example only. The quality window is not displayed.

As long as the power line voltage falls within the quality window with the parameters you specified, the THM 500 series instruments will show "PASS" in the upper left corner. Press any button to cancel the test.

When a failure occurs, the THM 500 series instruments will show "FAIL" in the upper left corner. A notation of the number of failures and, in the THM 565, the time and date of the last failure.

Displaying PWM Motor Drive Waveforms (THM 565)

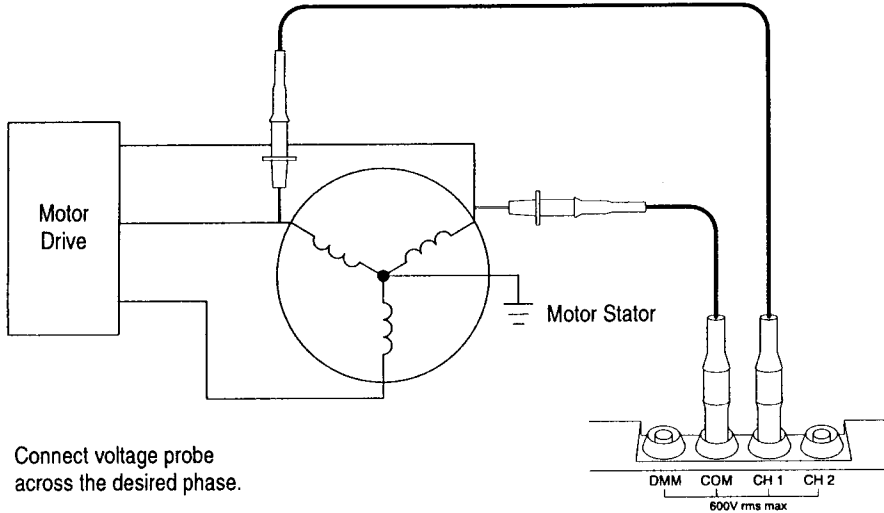

Connect voltage probe across the desired phase.

WARNING. To prevent injury or loss of life, do not make high voltage measurements without the use of safety gloves.

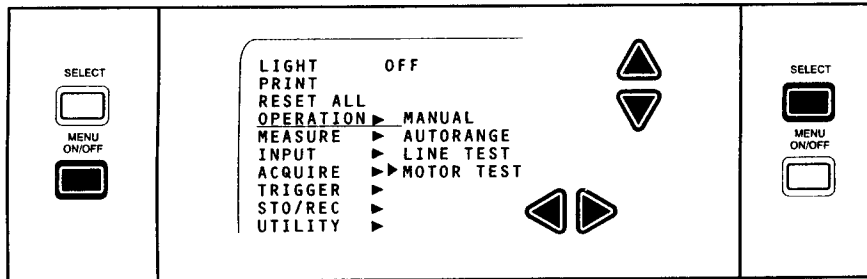

Display menu.

Select Motor Test.

Select.

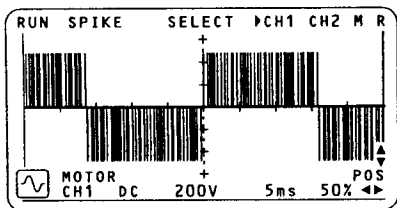

One phase of the inverter output is displayed.

Turn on the cursors to measure time and voltage.

Three Phase Voltage (THM 560 and THM 565) Delta (Δ) Configuration

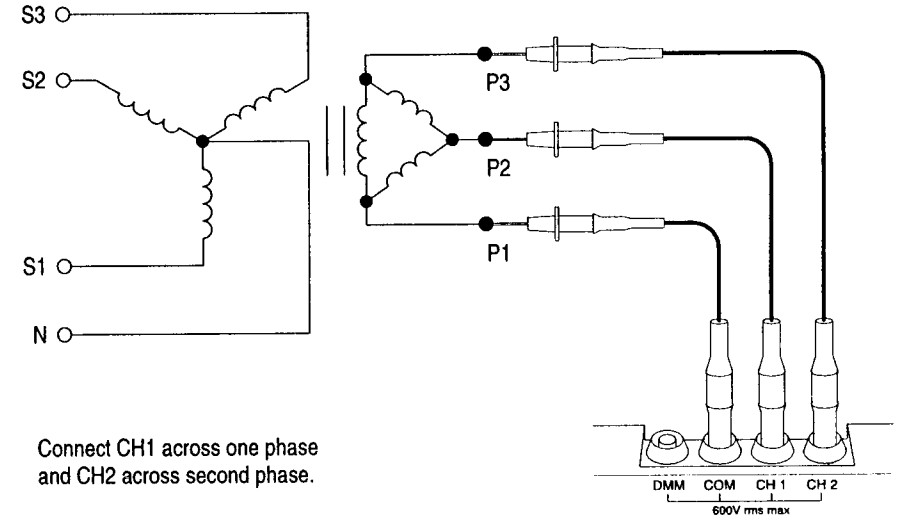

Connect CH1 across one phase and CH2 across second phase.

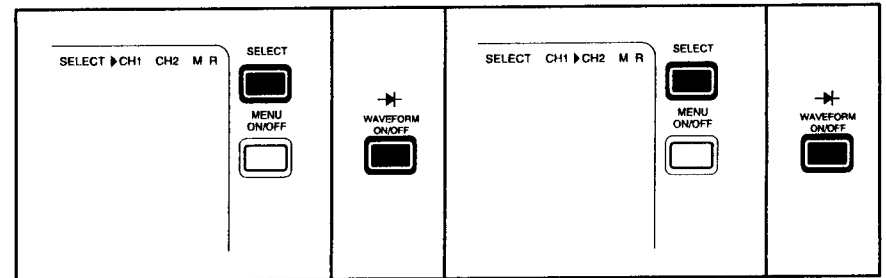

Select CH1 to show first phase.

Push to turn on.

Select CH2 to show second phase.

Push to turn on.

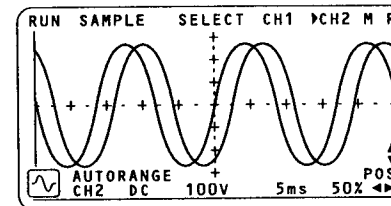

Channel 1 displays the P2 – P1 phase.

Channel 2 displays the P3 – P1 phase.

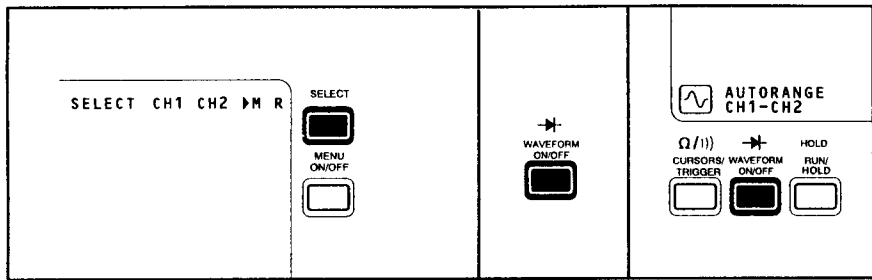

Select M to display the math waveform.

Push to turn on.

Press to turn waveform displays on or off.

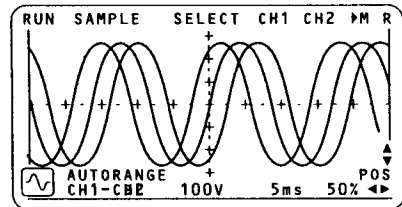

The math waveform (CH1 - CH2) provides the P2 - P3 phase.

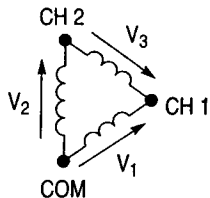

Notice that the waveforms are displayed 60° from one another.

V_2 and V_3 are 120° apart. Since V_1 is measured in the opposite direction (counterclockwise), it is displayed 180° out of phase from where it would be if measured in the clockwise direction.

Three Phase Voltage (THM 560 and THM 565) Wye (Y) Configuration

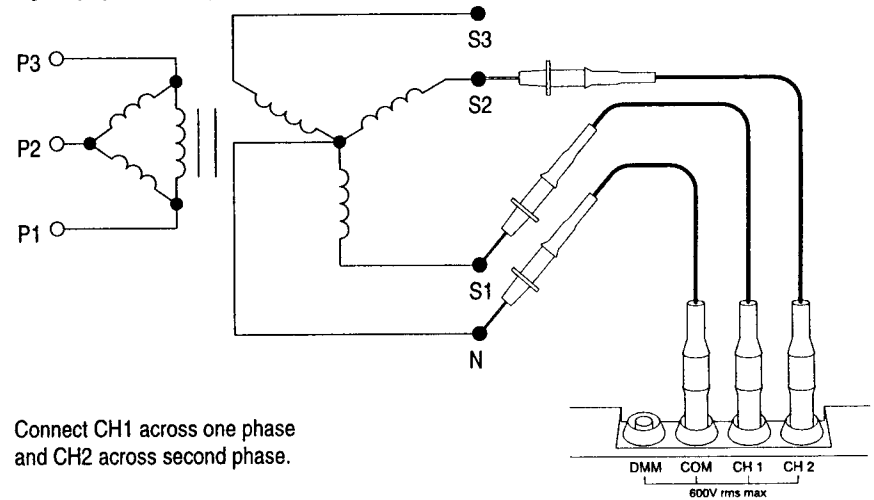

Connect CH1 across one phase and CH2 across second phase.

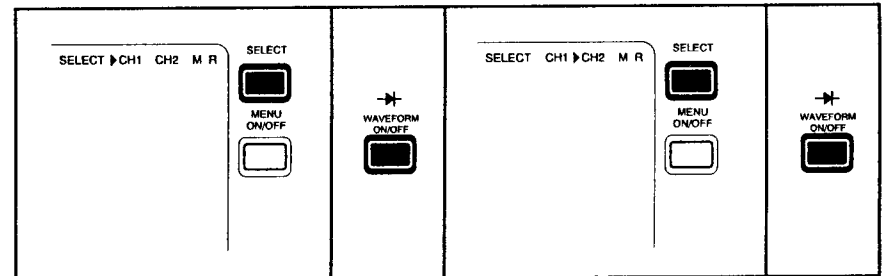

Select CH1 to show first phase.

Push to turn on.

Select CH2 to show second phase.

Push to turn on.

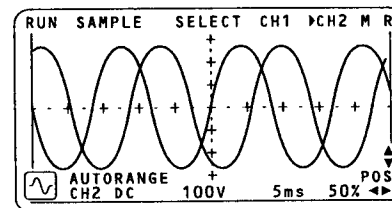

Channel 1 displays the S1 phase.

Channel 2 displays the S2 phase.

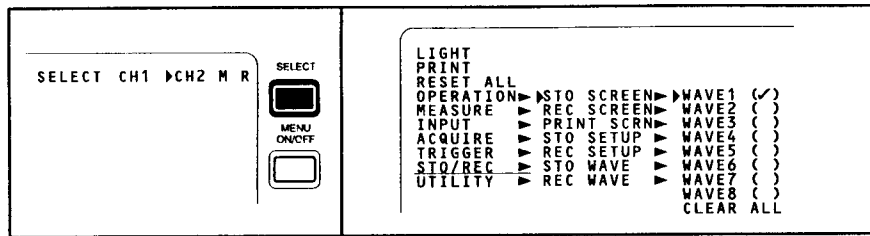

Select CH2 to store the channel 2 waveform to memory.

Store the channel 2 waveform in a waveform memory location.

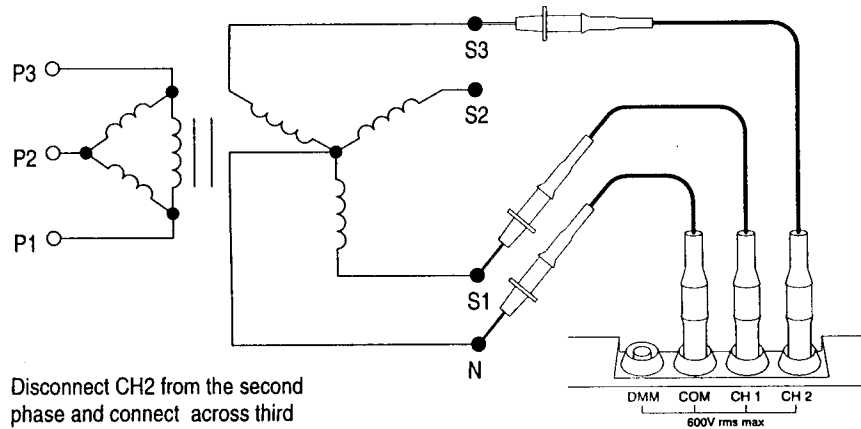

Disconnect CH2 from the second phase and connect across third phase.

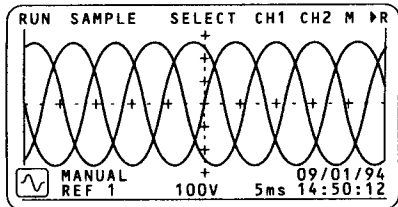

Channel 1 displays the S1 phase.

Channel 2 displays the S3 phase.

The Reference waveform "R" displays the S2 phase. The THM 565 displays the date and time the reference waveform was saved.

Note: This measurement is only valid for steady state waveforms since one waveform is a reference waveform and two are real time waveforms.

Transformer Harmonic Derating Factor (THDF)

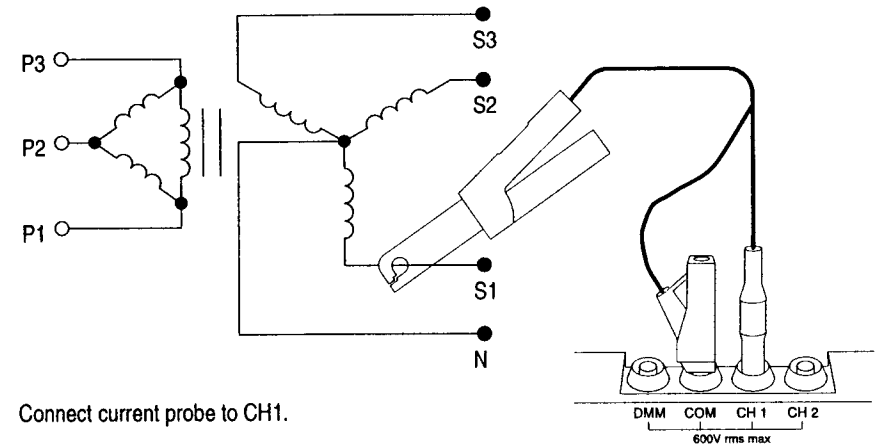

Connect current probe to CH1.

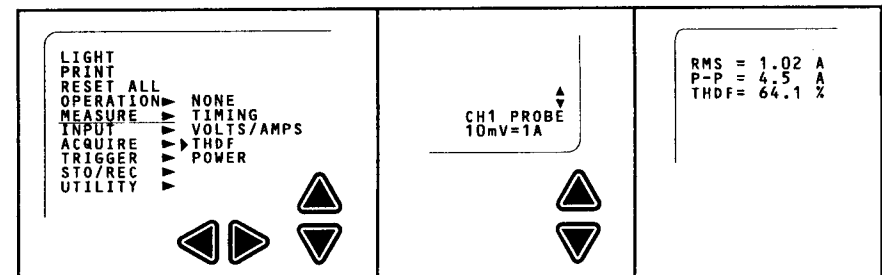

Use menu to select THDF measurement.

Set current probe scale.

Read results on display.

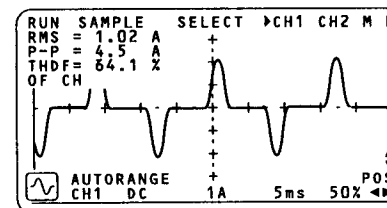

Transformer Harmonic Derating Factor (THDF) is calculated as follows:

$$THDF = \frac{RMS\ Current \times \sqrt{2}}{Peak\ Current}$$

The THDF measurement should be performed on each phase of a transformer.

The THDF value is a first order look at harmonic currents. Excessive harmonic currents in a transformer can cause overheating of both the neutral wire and transformer. The lowest THDF value for the three phases should be used as the number to derate the transformer. For example, with THDF readings of 64.1% for phase 1 and 74% for phases 2 and 3, the transformer should only be used up to 64% of its power rating.

Measuring True Power (THM 560, THM 565)

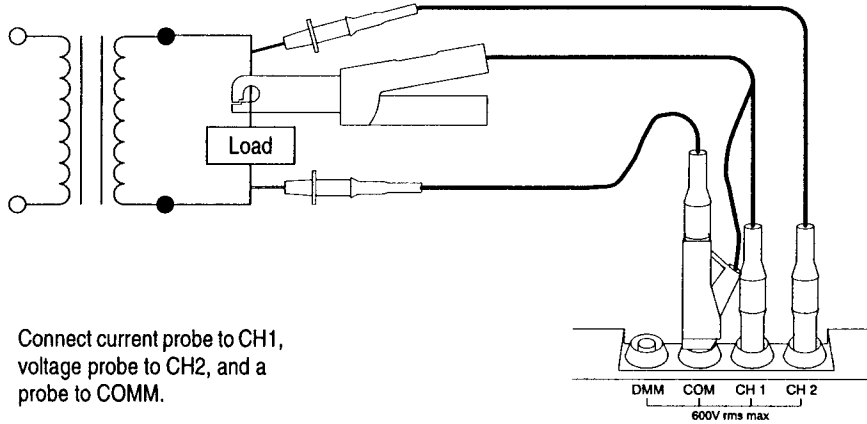

Connect current probe to CH1, voltage probe to CH2, and a probe to COMM.

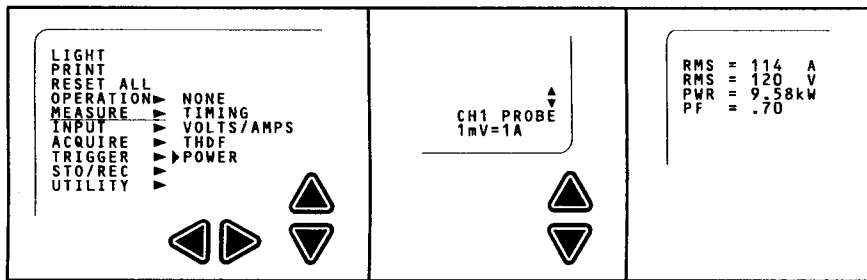

Use menu to select power measurement. Press the Select button.

Set current probe scale.

Read results on the display.

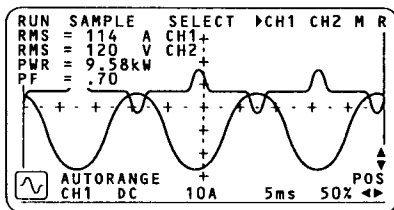

Channel 1 provides the Current waveform and the RMS current measurement is displayed.

Channel 2 provides the Voltage waveform and the RMS voltage measurement is displayed.

True power is measured and the measurement is displayed.

PF (power factor) is calculated as:

$$PF = \frac{\text{True Power}}{\text{RMS Current} \times \text{RMS Voltage}}$$

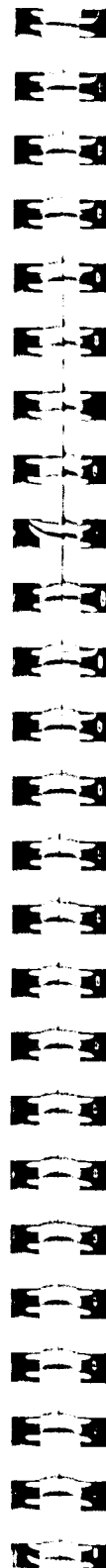

Appendix A: Specifications

To meet specifications, the instrument must have been operating continuously for five minutes within the operating temperature range specified. Specifications are warranted unless noted “typical.”

Table 1: DMM Specifications

550 | 560 | 565

General		550	560	565												
Resolution	3¾ digit, –4,000 count full scale reading except as noted	•	•	•												
Input Impedance, DC or AC Volts	10 MΩ typical <10 pF typical <70 pF typical at 400 mV range	•	•	•												
Additional Readouts	MIN: minimum voltage or resistance. MAX: maximum voltage or resistance. MAX–MIN: difference between MAX and MIN. HOLD: value of the main reading when the HOLD button is pressed. ΔHOLD: difference between HOLD reading and active reading.	•	•	•												
DC Voltage		550	560	565												
Range and Resolution	<table border="1"> <thead> <tr> <th>Range</th> <th>Resolution</th> </tr> </thead> <tbody> <tr> <td>400.0 mV</td> <td>0.1 mV</td> </tr> <tr> <td>4.000 V</td> <td>1 mV</td> </tr> <tr> <td>40.00 V</td> <td>10 mV</td> </tr> <tr> <td>400.0 V</td> <td>100 mV</td> </tr> <tr> <td>850 V</td> <td>1 V</td> </tr> </tbody> </table> Autorange available; selects from all ranges except 400.0 mV.	Range	Resolution	400.0 mV	0.1 mV	4.000 V	1 mV	40.00 V	10 mV	400.0 V	100 mV	850 V	1 V	•	•	•
Range	Resolution															
400.0 mV	0.1 mV															
4.000 V	1 mV															
40.00 V	10 mV															
400.0 V	100 mV															
850 V	1 V															
Accuracy	±(0.5% of reading + 5 counts)	•	•	•												
Normal Mode Rejection	> 60 dB typical at user-selectable 50 Hz or 60 Hz	•	•	•												
Common Mode Rejection	> 100 dB typical at user-selectable 50 Hz or 60 Hz	•	•	•												

Table 1: DMM Specifications (Cont.)

		550	560	565														
AC Voltage																		
Range and Resolution	All measurements are true RMS. <table border="1"> <thead> <tr> <th>Range</th> <th>Resolution</th> </tr> </thead> <tbody> <tr> <td>400.0 mV</td> <td>0.1 mV</td> </tr> <tr> <td>4.000 V</td> <td>1 mV</td> </tr> <tr> <td>40.00 V</td> <td>10 mV</td> </tr> <tr> <td>400.0 V</td> <td>100 mV</td> </tr> <tr> <td>600 V</td> <td>1 V</td> </tr> </tbody> </table> Autorange available; selects from all ranges except 400.0 mV.	Range	Resolution	400.0 mV	0.1 mV	4.000 V	1 mV	40.00 V	10 mV	400.0 V	100 mV	600 V	1 V	•	•	•		
Range	Resolution																	
400.0 mV	0.1 mV																	
4.000 V	1 mV																	
40.00 V	10 mV																	
400.0 V	100 mV																	
600 V	1 V																	
Accuracy	±(2% of reading + 5 counts) for 50 Hz or 60 Hz sine wave. Add 2% or reading + 5 counts for non-sinusoidal signal with crest factor <3.	•	•	•														
Ω/Resistance																		
Range and Resolution	<table border="1"> <thead> <tr> <th>Range</th> <th>Resolution</th> </tr> </thead> <tbody> <tr> <td>400.0 Ω</td> <td>0.1 Ω</td> </tr> <tr> <td>4.000 KΩ</td> <td>1 Ω</td> </tr> <tr> <td>40.00 KΩ</td> <td>10 Ω</td> </tr> <tr> <td>400.0 KΩ</td> <td>100 Ω</td> </tr> <tr> <td>4.000 MΩ</td> <td>1 KΩ</td> </tr> <tr> <td>40.00 MΩ</td> <td>10 KΩ</td> </tr> </tbody> </table> Autorange available.	Range	Resolution	400.0 Ω	0.1 Ω	4.000 KΩ	1 Ω	40.00 KΩ	10 Ω	400.0 KΩ	100 Ω	4.000 MΩ	1 KΩ	40.00 MΩ	10 KΩ	•	•	•
Range	Resolution																	
400.0 Ω	0.1 Ω																	
4.000 KΩ	1 Ω																	
40.00 KΩ	10 Ω																	
400.0 KΩ	100 Ω																	
4.000 MΩ	1 KΩ																	
40.00 MΩ	10 KΩ																	
Accuracy	±(0.5% of reading + 2 counts) except 40 MΩ range which is ±(2% of reading + 5 counts) at ≤60% relative humidity. Derate 4 MΩ range to ±(1% of reading + 2 counts) from 60%–90% relative humidity.	•	•	•														
Diode Test																		
Range	0 to 2 Volts. Red input connector is positive.	•	•	•														
Continuity Check																		
Indication	Audible tone (optionally disabled) and a graphic displaying a closed switch is displayed when resistance <50 Ω typical.	•	•	•														

Table 2: Scope Specifications

		550	560	565						
Modes										
Autorange (Default)	Autorange mode positions and sets the vertical and horizontal scales to between 30% and 60% of full screen (typical). After 500 ms, the process repeats if signal amplitude or period changes. Lower limits of Autorange are 50 mV/div and 100 ms/div.	•	•	•						
Manual	Scope goes into manual mode when any control that alters the waveform display is activated.	•	•	•						
Line Test	Will monitor a 45 to 65 Hz power waveform on CH1 and check for variations in amplitude and frequency. Abnormal events such as spikes, drop-outs, and substantial frequency variation will be captured and counted. Automatic print of failures. Automatic screen save on failures. Time and date stamp on failure.		•	•						
Motor Test	Will stabilize (trigger) on Pulse Width Modulated signals generated by Variable AC Motor Drives.			•						
Vertical										
Channels	Channels (multiple channels are identical).	1	2	2						
Probe Interface	Shrouded banana jack; accepts 4 mm caged-spring safety style banana plug. Use only probes incorporating 9 leaf-spring contacts.	•	•	•						
Digitizers	8 bits, 25 MSamples/second.	1	2	2						
Volts/Division Range	5 mV/div to 500 V/div in a 1–2–5 sequence.	•	•	•						
Modes	Normal, Invert.	•	•	•						
Coupling	DC, AC, COM (COM simulated).	•	•	•						
Input Impedance, DC Coupled	≥975 kΩ, ≤10 pF	•	•	•						
Analog Bandwidth	<table border="1"> <tbody> <tr> <td>5 mV/div</td> <td>DC to 1 MHz</td> </tr> <tr> <td>10 mV/div to 2 V/div</td> <td>DC to 5 MHz</td> </tr> <tr> <td>5 V/div to 500 V/div</td> <td>DC to 1 MHz</td> </tr> </tbody> </table>	5 mV/div	DC to 1 MHz	10 mV/div to 2 V/div	DC to 5 MHz	5 V/div to 500 V/div	DC to 1 MHz	•	•	•
5 mV/div	DC to 1 MHz									
10 mV/div to 2 V/div	DC to 5 MHz									
5 V/div to 500 V/div	DC to 1 MHz									

Table 2: Scope Specifications (Cont.)

550 | 560 | 565

Vertical				
Maximum Input Voltage	600 V _{RMS} . See Surge Protection under Safety.	•	•	•
Accuracy (Vertical DC Delta Voltage Accuracy)	±(3.5% + 2 pixels), 19° C to 27° C; derate by 0.25% per °C outside that range. Derate additional 0.5% at 5 mV/div. Linear range is ±8 divisions from COM (com- mon).	•	•	•
Crosstalk Between Channels	≥100:1 at 5 MHz, with other channel connected to COM (common).		•	•
Mathematics	Subtract (CH1-CH2), Add (CH1+CH2).		•	•
Acquisition				
Modes	Sample (Normal), Spike Detect, Roll, Run/Hold, Smooth, Dynamic DSP.	•	•	•
Acquisition Rate	Up to five waveforms per second in all modes except Dynamic DSP. Dynamic DSP mode: up to 750 waveforms per second, which are then displayed at a slower rate.	•	•	•
Horizontal				
Time/Division Range	60 s/div to 200 ns/div in a 1-2-5 sequence.	•	•	•
Time Base Accuracy	±(0.1% + 1 pixel)	•	•	•
Record Length	256 points	•	•	•
Spike Detect	Capture spikes down to 40 ns at all sweep speeds.	•	•	•
Single Shot	Single shot on two channels simultaneously.	•	•	•
Roll	200 ms/div to 60 s/div	•	•	•
Measurements				
Cursors	Voltage difference between cursors (ΔV). Time difference between cursors (ΔT). Reciprocal of ΔT in Hertz (1/ΔT).	•	•	•
Voltage (and Amps when using current probe)	Maximum (MAX), Minimum (MIN), Peak-Peak (P-P).	•	•	•
Timing	Frequency (FREQ), Period (PER).	•	•	•

Table 2: Scope Specifications (Cont.)

550 | 560 | 565

Measurements				
Power	Calculates true RMS current, voltage, true power, and power factor from CH1 current (using current probe) and CH2 voltage.		•	•
THDF (Transformer Harmonic Derating Factor)	Calculated as [(RMS Current × 1.41414) ÷ Peak Current], as read from a current probe on CH1.		•	•
Trigger				
Source	CH1 (Default) CH2	•	•	•
Modes	Auto-Level — default when in AutoRange mode Auto — default in manual operation Normal — user selectable Single-Shot — user selectable	•	•	•
Slope	Positive or Negative slope.	•	•	•
Sensitivity (Edge-type, DC Coupled)	0.5 division — 200 mV/div to 500 V/div 1 division — 10 mV/div to 100 mV/div 2 divisions — 5 mV/div	•	•	•
Waveform Display				
Display Update Rate	Dynamic Display Digital Signal Processing maps up to 750 waveforms/sec on screen, simulating analog-like display.	•	•	•
Memories				
Setups	Each setup memory stores the complete state of instrument including the state of multimeter.	4	4	8
Waveforms	Each waveform memory stores all waveform points and scale of the selected waveform.	4	4	8
Screens	Each screen memory stores the exact information that is displayed on screen; a screen snapshot.	1	1	8

Table 3: General Specifications		550	560	565
Real Time Clock	Provides date and time stamp capability for line test events and saved waveforms.			•
Display System				
Display Type	Super Twisted Liquid Crystal Display (LCD)	•	•	•
Size	Width 120 mm (4.72 in) nominal, Height 60 mm (2.36 in) nominal	•	•	•
Display Resolution	256 pixels horizontal × 128 pixels vertical	•	•	•
Contrast	User adjustable	•	•	•
Backlight	Electroluminescent			•
Waveform Graticule	8 divisions vertical × 10 divisions horizontal crosshair (default), grid, or none 1 vertical division = 15 pixels 1 horizontal division = 25 pixels	•	•	•
Power Source				
Batteries	Six size AA cells (9 V nominal)	•	•	•
Battery Life, typical	4.5 hours continuous operation with alkaline cells (backlight off). Tested using RAYOVAC® Alkaline MAXIMUM™ batteries. Note: Battery life is extended when used intermittently.	•	•	•
Battery Saver	User time adjustable Battery Saver feature turns the instrument off after 5 minutes, backlight off after 1 minute. Times are user adjustable.	•	•	•
Memory Retention Time	Memory holdup time when batteries are removed: eight minutes minimum, three hours typical. Note: Memory retention is much longer (weeks or months) if even discharged batteries remain installed.	•	•	•

Table 3: General Specifications (Cont.)		550	560	565
Environmental				
Temperature	+0° C to +50° C Operating. –20° C to +70° C Storage.	•	•	•
Humidity, Operating	+0° C to +40° C, up to 90% RH non-condensing (60% for 4 MΩ and 40 MΩ measurements), +41° C to +50° C, 60% RH non-condensing.	•	•	•
Altitude	2,200 m (7,221 ft) operating, 12,192 m (40,000 ft) storage.	•	•	•
Random Vibration	2.66 g _{RMS} , 5 to 500 Hz, 10 min/axis, operating. 3.48 g _{RMS} , 5 to 500 Hz, 10 min/axis, non-operating.	•	•	•
Sine Vibration, Operating	0.06 in. displacement from 5 to 15 Hz, 0.04 in. displacement from 15 to 25 Hz, 0.02 in. displacement from 25 to 55 Hz. Duration of test is 10 minutes at the peak resonance condition (33 Hz if no resonance is found). Test is performed on each of three axis.	•	•	•
Halfsine Shock, Operating	30 g with pulse duration of 11 ms. Three shocks per axis. Duration of test is 10 minutes at the peak resonance condition (33 Hz if no resonance is found). Test is performed on each of three axis.	•	•	•
EMC				
Emissions	EN 55011 radiated, class A.	•	•	•
Immunity	IEC 801-2 electrostatic discharge — up to 8 kV, IEC 801-3 radiated immunity — 3 V/meter, 27 MHz to 500 MHz.	•	•	•
Mechanical				
Size	Height 140 mm (5.5 in), Width 210 mm (8.3 in), Depth 43 mm (1.7 in)	•	•	•
Weight	1 kg (2.2 lb) with Alkaline Batteries installed	•	•	•
Tripod Socket	1/4 in × 20 thread, 6.3 mm (0.25 in) deep	•	•	•

Table 3: General Specifications (Cont.)

		550	560	565
Safety				
Certifications	Listed UL 1244 for 600V measurements; CSA-C22.2 No 231 Series-M89	•	•	•
Surge Protection	Withstands incidental line surges up to 6 kV, minimum rise time of 1.2 μ s, maximum 50 μ s duration, minimum of 2 minutes between pulses. Maximum volt-hertz product is 50 V-MHz.	•	•	•
Fuse	This instrument has no user-replaceable fuses.	•	•	•
General	Safety Class 2	•	•	•

Appendix B: Optional Accessories

Several accessories are available for the THM 550, THM 560, and THM 565 TekMeters.

Table 4: Optional Accessories







TXMDXPB Deluxe Probe Set	
	The deluxe probe set provides more configurations in a wider environmental range than the standard probes that are shipped with the THM 500 series instruments. The cables are insulated with a heat-resistant silicon insulation which can be used around hot manifolds, pipes, and soldering irons. Tips provided with the deluxe probe set have several jaws that allow connection to a wide variety of test points.
THM5BAT Battery Pack	
	The rechargeable battery eliminates the need to repeatedly purchase alkaline batteries. The battery pack uses long-life 750 mA/hr nickel-cadmium batteries.
THM5CHG Battery Charger	
	The battery charger recharges the THM5BAT Battery Pack in one hour. It can be powered from wall power or from a 12 V automobile cigarette lighter.
THMCOM1 Communications Adapter	
	The communications adapter provides an RS-232 adapter to connect a printer to the THM 500 series instruments or the THM 500 series instruments to a computer. The communications adapter includes a stand for easy desktop operation of the THM 500 series instruments at a comfortable viewing angle. The included AC/DC power adapter also allows the THM 500 series instruments to be operated from wall power or by 12 V power from an automobile cigarette lighter. PC-link software is included.
THM5AC Power Adapter	
	The AC power adapter allows you to operate the THM 500 series instruments from AC wall power.

Table 4: Optional Accessories (Cont.)

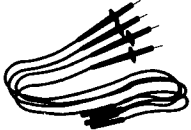
THM5HCA Transport Case	
	The transport case provides ultimate protection for the THM 500 series instruments when shipped or transported via commercial carrier. The transport case has room for a THM 500 series instrument, probes and accessories, and a current probe.
THM5SCA Soft Case/Hands-Free Pouch	
	The soft case/hands-free pouch protects the THM 500 series instruments both during use and in transport. The pouch holds a THM 500 series instrument in a viewing position with a single fully-adjustable neck strap, allowing hands-free operation. When closed, it becomes a soft carrying case. The soft case/hands-free pouch provides a compartment for the probes and probe tips.
A605, A621, and A622 Current Probes	
	<p>Three Tektronix current probes extend the THM 500 series instruments to handle current and power measurements. These clamp-on probes do not require disconnections to insert the meter into the circuit. All three current probes include safety banana-jack adapters to connect to the THM 500 series instruments and still allow other channel's probes to connect to the common reference.</p> <p>A605: AC only, 500 A max, 48 Hz to 1 kHz, output at 1 mV/A.</p> <p>A621: AC only, 2,000 A max, 5 Hz to 50 kHz, selectable output at 1, 10, or 100 mV/A.</p> <p>A622: AC or DC, 100 A max, DC to 100 kHz, selectable output at 10 or 100 mV/A.</p>
REP4100 Service Assurance — Repair Protection	
	Provides one year of post-warranty repair support. Available in one-year increments up to three years.
CAL4100 Service Assurance — Calibration Services	
	Provides one year of calibration support. Available in one-year increments up to five years.

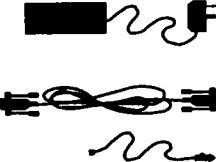

Appendix C: Troubleshooting

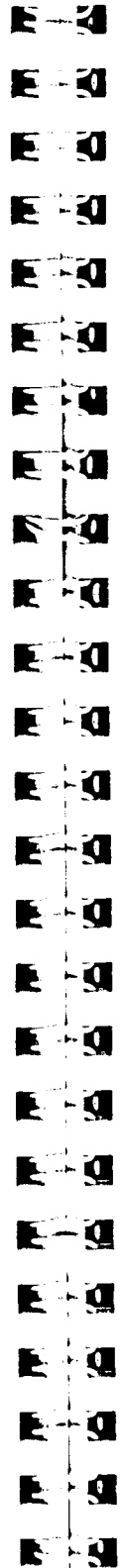
Instrument Problems

If you experience trouble with your THM 500 series instrument, try these corrective actions before concluding that repair is needed.

1. Make sure you are using fresh alkaline batteries or fully charged rechargeable batteries. If you are using the AC/DC power adapter included with the THMCOM1 Communications Adapter or the THM5AC Power Adapter, make sure the adapter is plugged into an appropriate live power source.
2. If the buttons do not respond to your control or the contrast is set such that the display is unreadable, remove the power source *while the THM 500 series instrument is on*. Wait 15 minutes, then restore power and try operations.
3. If the buttons do respond to your control but you still experience difficulty, use the menu to Reset All. This puts the THM 500 series instruments into a factory default state, with the exception that the stored waveforms, setups, and screens are preserved.
4. If you still experience difficulty, use the menu to perform the diagnostics: UTILITY►DIAGNOSTIC►INTERNAL and UTILITY►DIAGNOSTIC►DISPLAY. If no error conditions are reported, check your connections and reread the usage instructions.

In rare cases, your THM 500 series instrument may require servicing. There are no user serviceable parts inside the THM 500 series instruments. For service, return the instrument to the Tektronix office in your location.

Reducing Noise Pickup

Picking up line signal noise is a typical problem when using sensitive measurement devices such as THM 500 Series instruments.

Here are some helpful hints to limit the amount of noise picked up by the THM 500 Series instrument:

- Keep the transformer line cord away from the measurement leads.
- Twist the measurement leads together, forming a “twisted pair.”
- In some situations, you may want to use a BNC-to-dual-banana adapter. This allows you to use shielded BNC cables and probes.

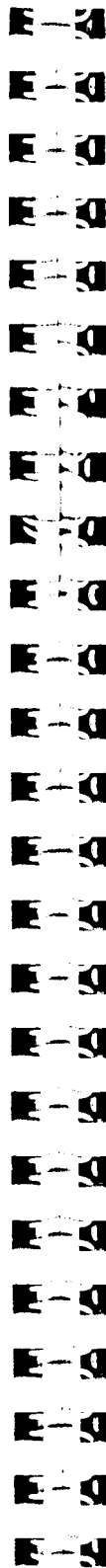

Appendix D: Replaceable Parts

Obtain replacement parts for THM 500 series instruments by contacting your distributor, the place of purchase, or your nearest Tektronix office. The replaceable parts that are available are listed below. There are no user-replaceable parts inside the THM 500 series instruments.

- Standard probe set, Tektronix part number 012-1447-xx.
- Battery holder with screws, Tektronix part number 200-4101-xx.
- Corner bumper, Tektronix part number 348-1344-xx. This part number is for one bumper.
- Instructions (manual), English language, Tektronix part number 070-8840-xx.

The Instructions are also available in these languages: French, Spanish, Portuguese, German, Italian, and Japanese.

- Performance Verification (manual), English language, Tektronix part number 070-8951-xx.